

UNIQUEslideMS

KALDIR ve SÜR KAPI SİSTEMİ

LIFT&SLIDE DOOR SYSTEM

X	PERFORMANS ve ISI HESAPLARI PERFORMANCE and THERMAL CALCULATIONS.....	X-01 / X-06
A	KANAT için STATİK DİAGRAM STATICAL DIAGRAM for SASH	A-01 / A-11
B	ALUMİNYUM PROFİLLER ALUMINIUM PROFILES	B-01 / B-07
C	CAM MONTAJ TALİMATI GLAZING ASSEMBLY	C-01 / C-04
D	CONTALAR GASKETS	D-01 / D-02
E	AKSESUARLAR ACCESSORIES	E-01 / E-06
F	PLASTİK PROFİLLER PLASTIC PROFILES	F-01
G	UYGULANABİLİR AÇILIM TİPLERİ APPLICABLE OPENING TIPOLOGIES	G-01
H	TAM ÖLÇEKLİ PROFİLLER FULL SCALE PROFILES.....	H-01 / H-20
J	PRENSİP SİSTEM DETAYLARI PRINCIPAL SECTIONS	J-01 / J-31
K	ÜRETİM TALİMATLARI MANUFACTURING INSTRUCTIONS.....	K-01 / K-70
L	KESİM LİSTELERİ CUTTING LISTS.....	L-01 / L-14

UNIQUEslideMS
KALDIR ve SÜR KAPI SİSTEMİ
LIFT&SLIDE DOOR SYSTEM

PERFORMANS ve THERMAL HESAPLAR
PERFORMANCE and THERMAL
CALCULATIONS

UNIQUEslideMS

LIFT&SLIDE KAPI SİSTEMİ

LIFT&SLIDE DOORSYSTEM

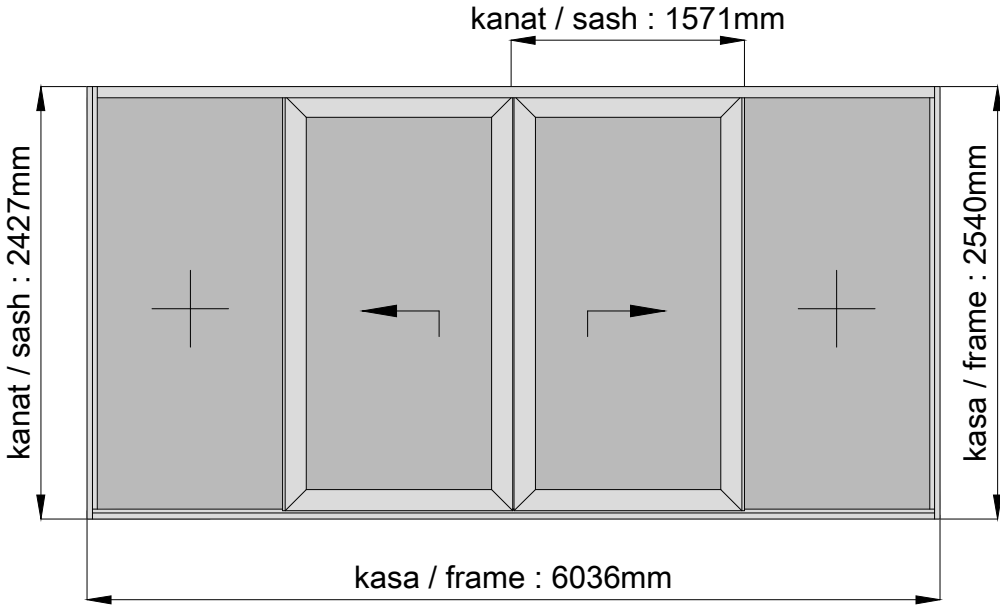
PERFORMANS TESTİ - performance test	
	
TS EN 12207 - HAVA GEÇİRGENLİĞİ TS EN 12207 - air permability	A 4 (± 600 pa) 600pascal
TS EN 12208 - SU SIZDIRMAZLIĞI TS EN 12208 - water tightness	E 900 (± 900 pa) 900pascal
TS EN 12210 - RÜZGAR YÜKÜ DAYANIMI TS EN 12210 - resistance to design wind load	B5 (2000pa) 2000pascal
TS EN 12210 - GÜVENLİK YÜKÜNE DAYANIMI TS EN 12210 - resistance to safety load	(3000pa) 3000pascal
LABORATUAR ve TEST RAPORU NUMARASI Laboratory and test report number	FTI facade testing institute 160.1708.1/2022

UNIQUEslideMS

LIFT&SLIDE KAPI SİSTEMİ

LIFT&SLIDE DOORSYSTEM

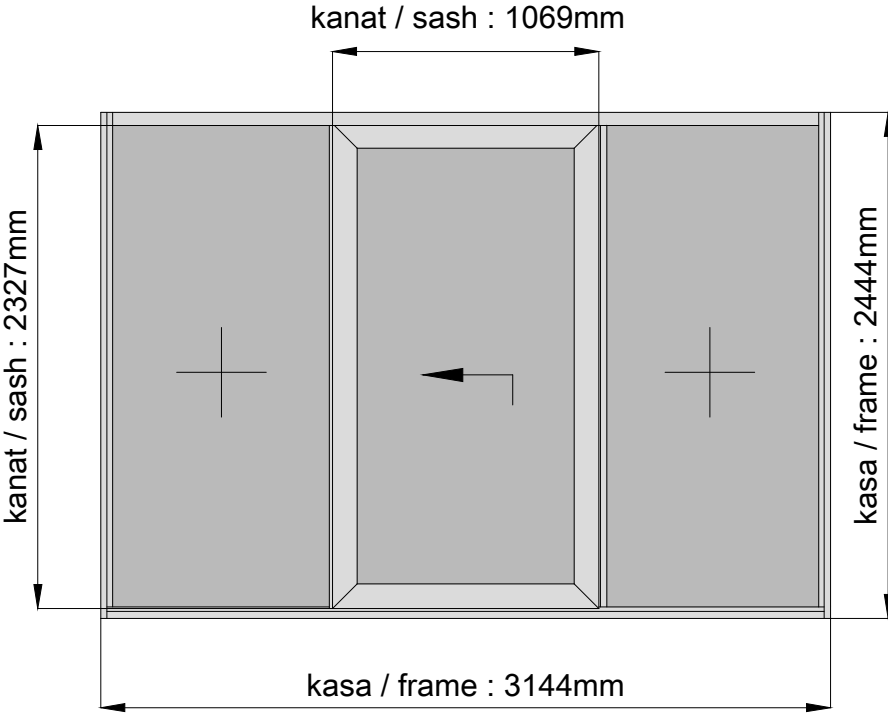
PERFORMANS TESTİ - performance test	
	
TS EN 12207 - HAVA GEÇİRGENLİĞİ TS EN 12207 - air permability	A 4 (± 600 pa) 600pascal
TS EN 12208 - SU SIZDIRMAZLIĞI TS EN 12208 - water tightness	E 900 (± 900 pa) 900pascal
TS EN 12210 - RÜZGAR YÜKÜ DAYANIMI TS EN 12210 - resistance to design wind load	B5 (2000pa) 2000pascal
TS EN 12210 - GÜVENLİK YÜKÜNE DAYANIMI TS EN 12210 - resistance to safety load	(3000pa) 3000pascal
LABORATUAR ve TEST RAPORU NUMARASI Laboratory and test report number	FTI facade testing institute 020.1671.1/2021

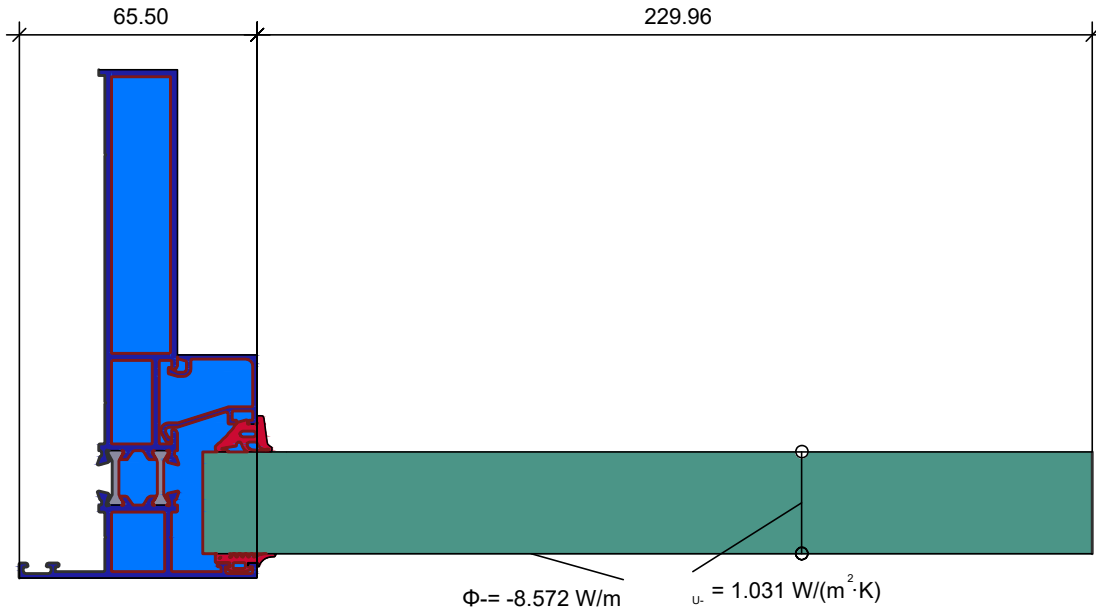

$$u_f = \frac{\frac{\Phi}{\Delta T} \cdot b_p}{b_f} = \frac{\frac{8.572}{20.000} - 1.031 \cdot 0.230}{0.066} = 2.92 \text{ W/(m} \cdot \text{K)}$$

Material	λ [W/(m·K)]	ϵ	Boundary Condition	q [W/m ²]	θ [C°]	R [(m·K)/W]	ϵ
Aluminium (Si Alloys)	160.000	0.900	Epsilon 0.9				0.900
EPDM (ethylene propylene diene monomer)	0.250	0.900	Exterior, frame	0.000		0.040	
Panel	0.035	0.900	Interior, frame, normal	20.000		0.130	
Polyamid 6.6 with 25% glass fibre	0.300	0.900	Interior, frame, reduced	20.000		0.200	
Slightly ventilated air cavity	anisotropic		Symmetry/Model section	0.000		0.000	
Unventilated air cavity	anisotropic						

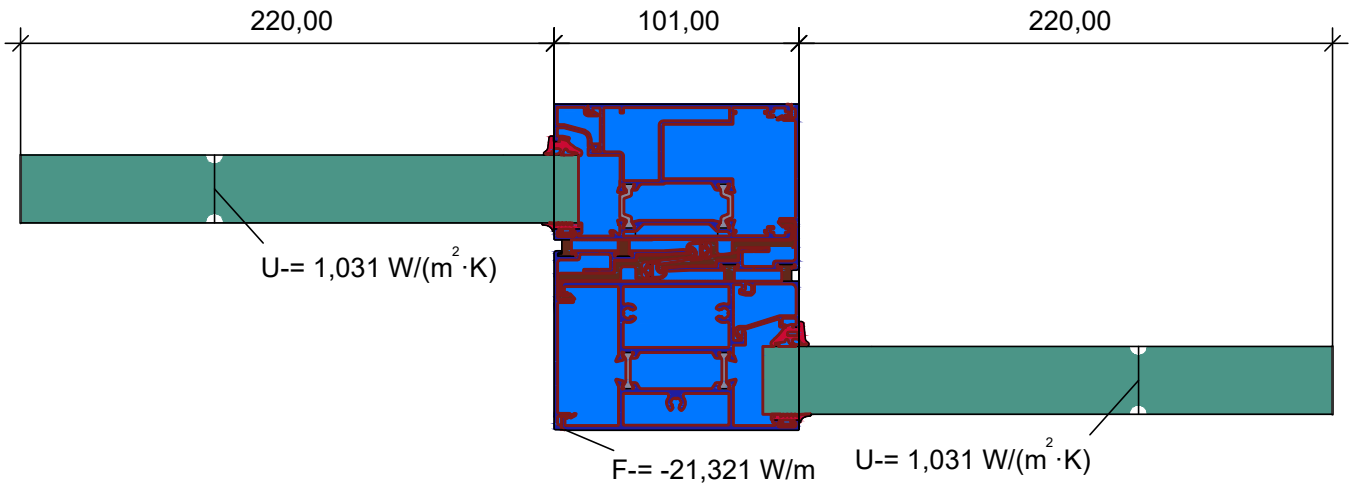

$$U_f = \frac{\Phi}{DT} = \frac{21,321}{20,000} = 1,066 \text{ W/(m}^2 \cdot \text{K)}$$

$$U_f = \frac{1,031 \cdot 0,220 + 1,031 \cdot 0,220}{0,101} = 6,06 \text{ W/(m}^2 \cdot \text{K)}$$

Material	λ [W/(m·K)]	ϵ	Boundary Condition	q [W/m ²]	θ [C°]	R [(m·K)/W]	ϵ
Aluminium (Si Alloys)	160.000	0.900	Epsilon 0.9				0.900
EPDM (ethylene propylene diene monomer)	0.250	0.900	Exterior, frame	0.000		0.040	
Panel	0.035	0.900	Interior, frame, normal	20.000		0.130	
Polyamid 6.6 with 25% glass fibre	0.300	0.900	Interior, frame, reduced	20.000		0.200	
Slightly ventilated air cavity	anisotropic		Symmetry/Model section	0.000			
Unventilated air cavity	anisotropic						

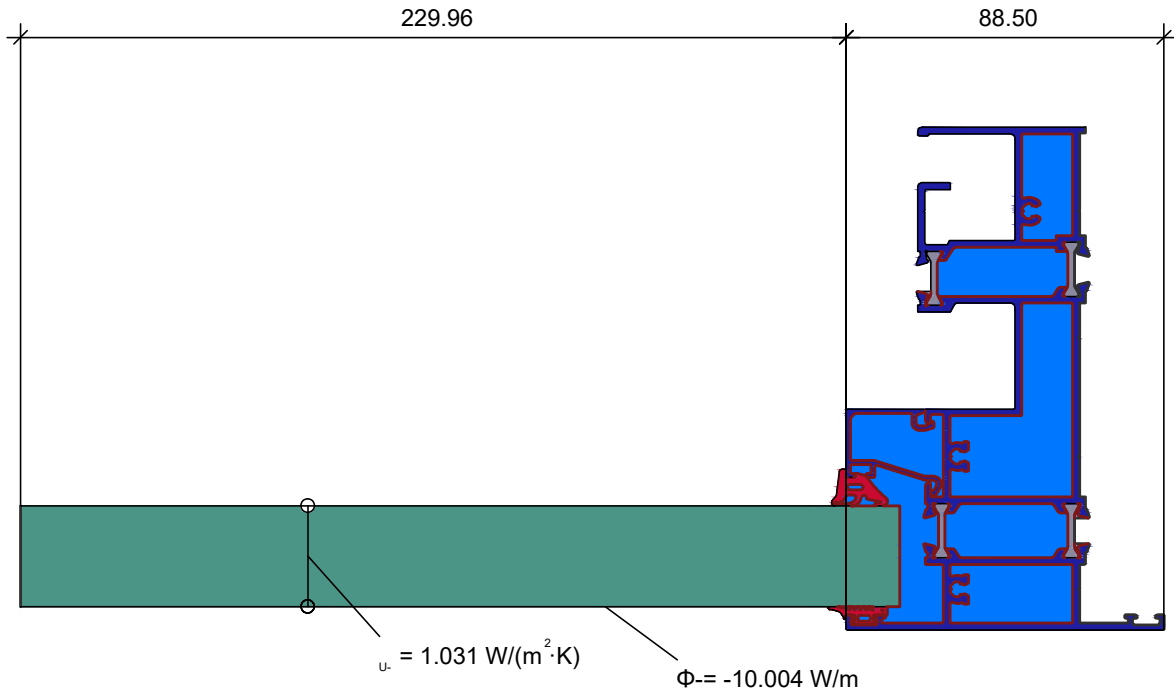

$$u_f = \frac{\frac{\Phi}{\Delta T} - U_p \cdot b_p}{b_f} = \frac{\frac{10.004}{20.000} - 1.031 \cdot 0.230}{0.089} = 2.97 \text{ W}/(\text{m} \cdot \text{K})$$

Material	λ [W/(m·K)]	ϵ	Boundary Condition	q [W/m ²]	θ [C]	R [(m·K) ² /W]	ϵ
Aluminium (Si Alloys)	160.000	0.900	Epsilon 0.9				0.900
EPDM (ethylene propylene diene monomer)	0.250	0.900	Exterior, frame	0.000		0.040	
Panel	0.035	0.900	Interior, frame, normal	20.000		0.130	
Polyamid 6.6 with 25% glass fibre	0.300	0.900	Interior, frame, reduced	20.000		0.200	
Slightly ventilated air cavity	anisotropic		Symmetry/Model section	0.000			
Unventilated air cavity	anisotropic						

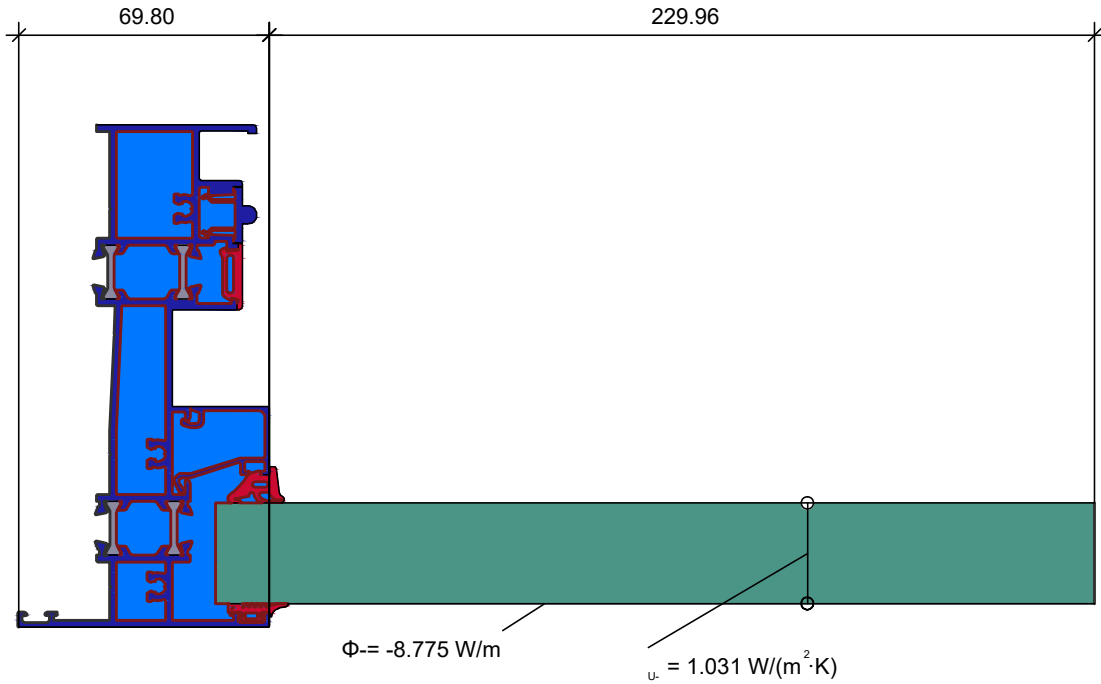

$$u_f = \frac{\frac{\Phi}{\Delta T} \cdot b_p}{b_f} = \frac{\frac{8.775}{20.000} - 1.031 \cdot 0.230}{0.070} = 2.89 \text{ W}/(\text{m} \cdot \text{K})$$

Material	λ [W/(m·K)]	ϵ	Boundary Condition	q [W/m ²]	θ [C°]	R [(m·K)/W]	ϵ
Aluminium (Si Alloys)	160.000	0.900	Epsilon 0.9				0.900
EPDM (ethylene propylene diene monomer)	0.250	0.900	Exterior, frame	0.000		0.040	
Panel	0.035	0.900	Interior, frame, normal	20.000		0.130	
Polyamid 6.6 with 25% glass fibre	0.300	0.900	Interior, frame, reduced	20.000		0.200	
Slightly ventilated air cavity	anisotropic		Symmetry/Model section	0.000			
Unventilated air cavity	anisotropic						

UNIQUEslideMS
KALDIR ve SÜR KAPI SİSTEMİ
LIFT&SLIDE DOOR SYSTEM

KANAT için STATİK DİAGRAM
STATICAL DIAGRAM for SASH

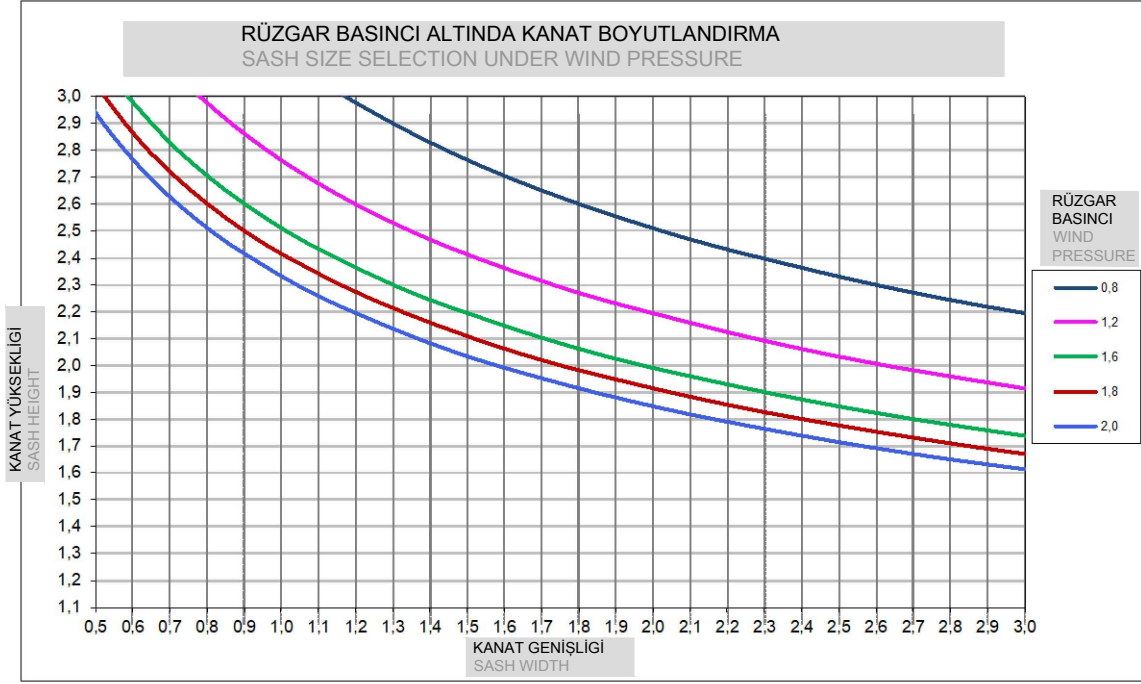

KANAT AĞIRLIĞI : 400kg
SASH WEIGHT : 400kg

SEHİM LİMİTİ L/200 yada 15mm dir.

FARKLI RENKLİ EGRİSEL ÇİZGİLER, FARKLI RÜZGAR BASINCLARI ALTINDA, UYGULANABİLİR MAKSİMUM KANAT BOYUTLARINI GÖSTERİR.

ÜSTTEKİ TABLOYA GÖRE SEÇİLEN KANAT BOYUTU, CAM TEDARİKÇİSİNE BİLDİRİLEREK, İZİN VERİLEN BOYUT ve SEHİMİN, SEÇİLEN

CAMA UYGUN OLUP OLMADIĞI TEYİD EDİLMELİ ve ONAY ALINMALIDIR.

DİKKAT:

Bu statik hesap şeması ön yapısal hesaplamalar ve profil seçimi için tasarlanmıştır.

Bu şema nihai yapısal hesaplama için bir alternatif değildir, Statik Rapor olarak kullanılamaz

Statik Hesaplar Mutlaka Uygulamacı Tarafından Yapılmalıdır.

DEFLECTION LIMIT L / 200 or 15mm.

THE LINE SHOW MAXIMUM SIZES FOR THE INDICATE PRESSURE.

VERIFY THAT THE DEFLECTION OF THE SECTION IS COMPATIBLE WITH THE EMPLOYED GLASS.

DIN EN 12210 for the standard building area

Deflection limit L/200 or max. 15mm in accordance with TRLV

Differing deflection limits set by the double glazing manufacturer must be observed.

These statics diagram are intended for preliminary structural calculations and profile selection.

This is not a substitute for a final structural calculation.

Sash sizes below the line are structurally adequate.

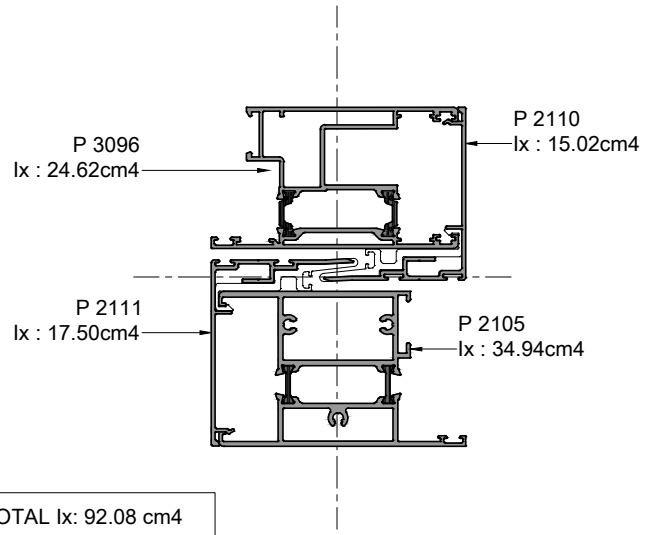
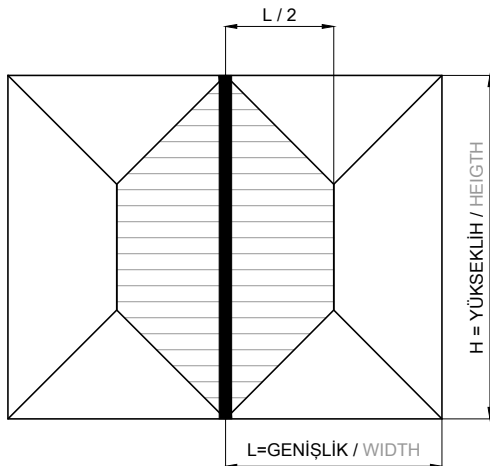

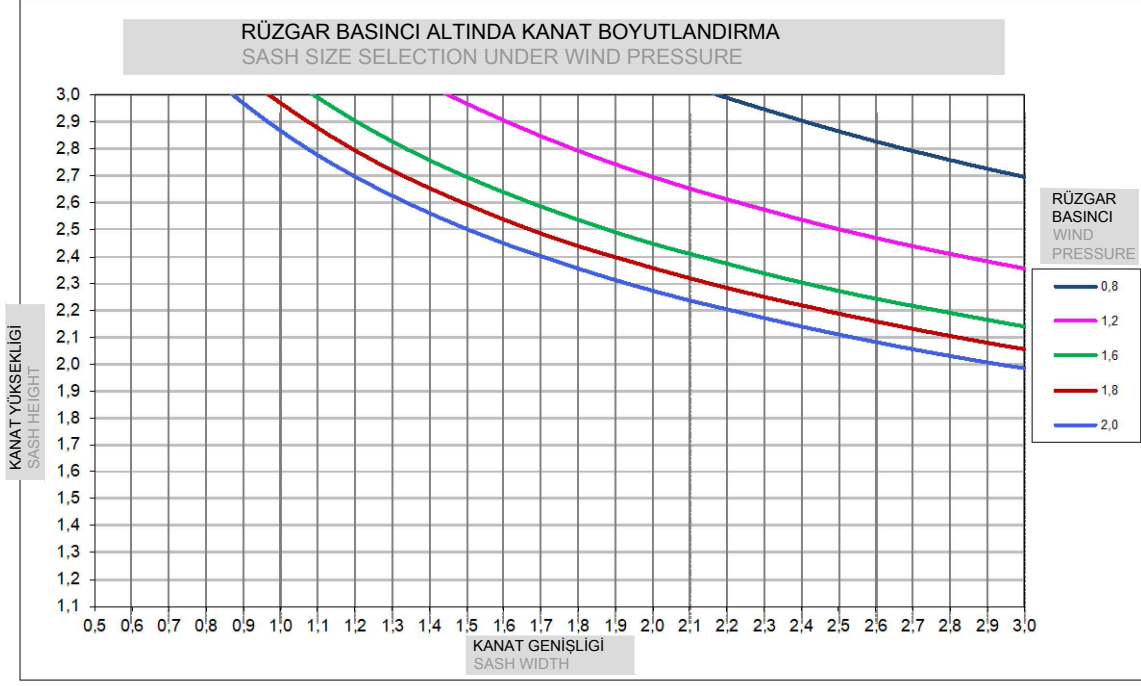

KANAT STATİK DİAGRAM
STATICAL DIAGRAM for SASH

KANAT AĞIRLIĞI : 400kg
SASH WEIGHT : 400kg

SEHİM LİMİTİ L/200 yada 15mm dir.

FARKLI RENKLİ EGRİSEL ÇİZGİLER, FARKLI RÜZGAR BASINCLARI ALTINDA, UYGULANABİLİR MAKSİMUM KANAT BOYUTLARINI GÖSTERİR.

ÜSTTEKİ TABLOYA GÖRE SEÇİLEN KANAT BOYUTU, CAM TEDARİKÇİSİNE BİLDİRİLEREK, İZİN VERİLEN BOYUT ve SEHİMİN, SEÇİLEN

CAMA UYGUN OLUP OLMADIĞI TEYİD EDİLMELİ ve ONAY ALINMALIDIR.

DİKKAT:

Bu statik hesap şeması ön yapısal hesaplamalar ve profil seçimi için tasarlanmıştır.

Bu şema nihai yapısal hesaplama için bir alternatif değildir, Statik Rapor olarak kullanılamaz

Statik Hesaplar Mutlaka Uygulamacı Tarafından Yapılmalıdır.

DEFLECTION LIMIT L / 200 or 15mm.

THE LINE SHOW MAXIMUM SIZES FOR THE INDICATE PRESSURE.

VERIFY THAT THE DEFLECTION OF THE SECTION IS COMPATIBLE WITH THE EMPLOYED GLASS.

DIN EN 12210 for the standard building area

Deflection limit L/200 or max. 15mm in accordance with TRLV

Differing deflection limits set by the double glazing manufacturer must be observed.

These statics diagram are intended for preliminary structural calculations and profile selection.

This is not a substitute for a final structural calculation.

Sash sizes below the line are structurally adequate.

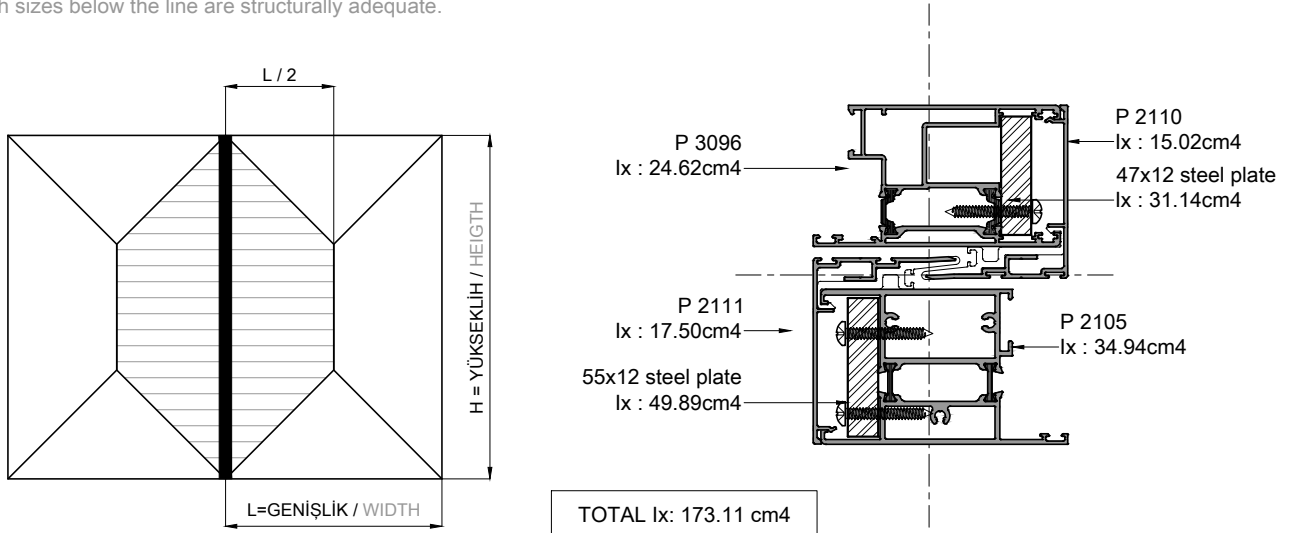

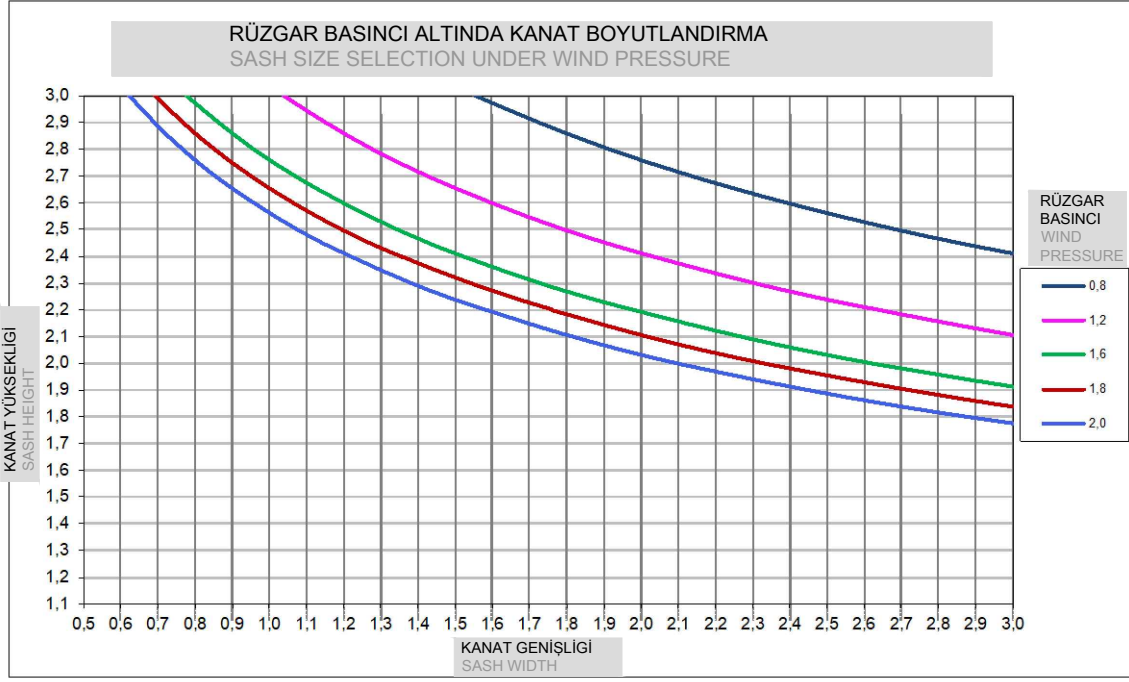

KANAT STATİK DİAGRAM
STATICAL DIAGRAM for SASH

KANAT AĞIRLIĞI : 400kg
SASH WEIGHT : 400kg

SEHİM LİMİTİ L/200 yada 15mm dir.

FARKLI RENKLİ EGRİSEL ÇİZGİLER, FARKLI RÜZGAR BASINCLARI ALTINDA, UYGULANABİLİR MAKSİMUM KANAT BOYUTLARINI GÖSTERİR.

ÜSTTEKİ TABLOYA GÖRE SEÇİLEN KANAT BOYUTU, CAM TEDARİKÇİSİNE BİLDİRİLEREK, İZİN VERİLEN BOYUT ve SEHİMİN, SEÇİLEN

CAMA UYGUN OLUP OLMADIĞI TEYİD EDİLMELİ ve ONAY ALINMALIDIR.

DİKKAT:

Bu statik hesap şeması ön yapısal hesaplamalar ve profil seçimi için tasarlanmıştır.

Bu şema nihai yapısal hesaplama için bir alternatif değildir, Statik Rapor olarak kullanılamaz

Statik Hesaplar Mutlaka Uygulamacı Tarafından Yapılmalıdır.

DEFLECTION LIMIT L / 200 or 15mm.

THE LINE SHOW MAXIMUM SIZES FOR THE INDICATE PRESSURE.

VERIFY THAT THE DEFLECTION OF THE SECTION IS COMPATIBLE WITH THE EMPLOYED GLASS.

DIN EN 12210 for the standard building area

Deflection limit L/200 or max. 15mm in accordance with TRLV

Differing deflection limits set by the double glazing manufacturer must be observed.

These statics diagram are intended for preliminary structural calculations and profile selection.

This is not a substitute for a final structural calculation.

Sash sizes below the line are structurally adequate.

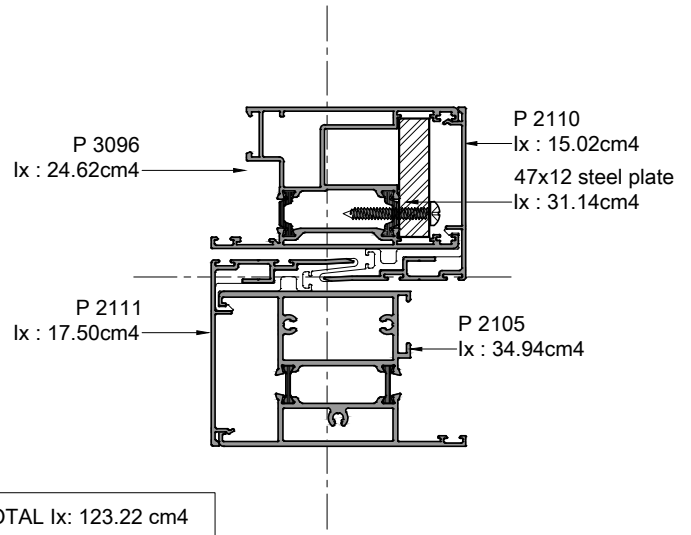
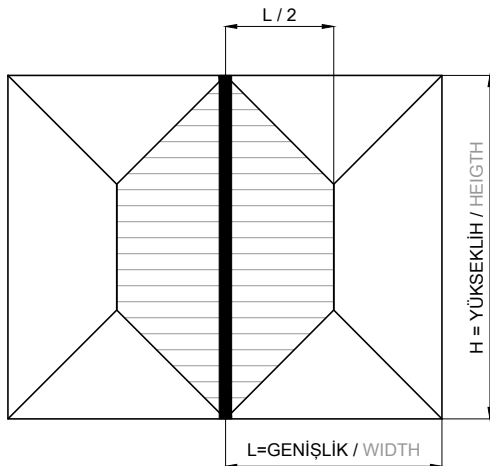

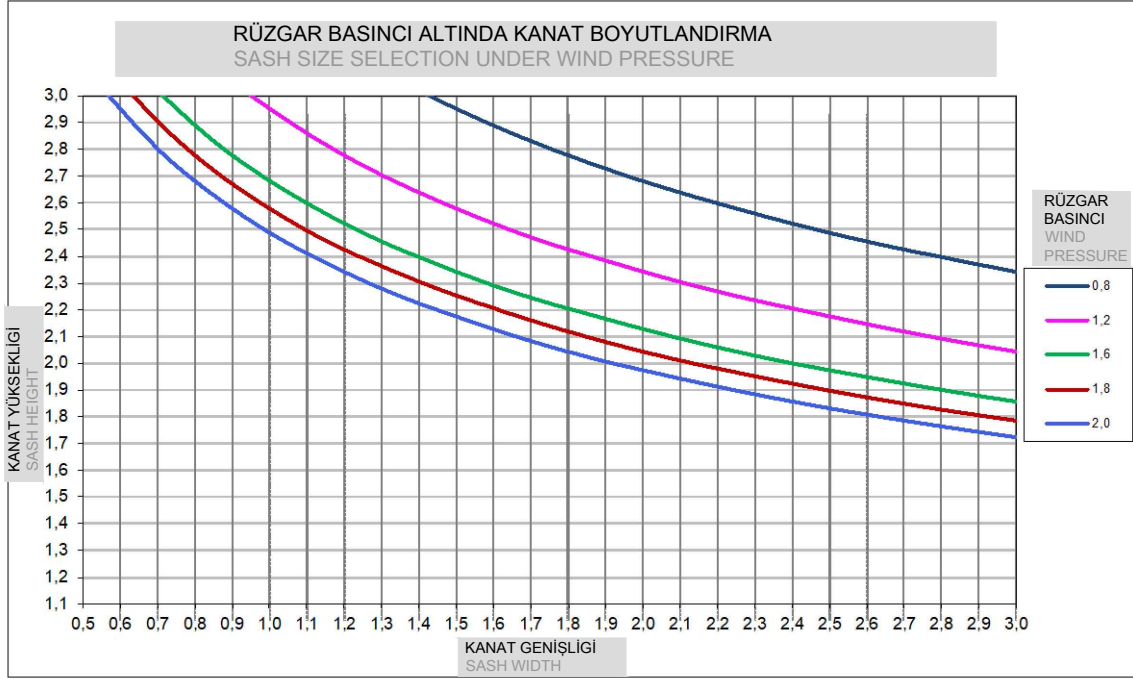

KANAT STATİK DİAGRAM
STATICAL DIAGRAM for SASH

KANAT AĞIRLIĞI : 400kg
SASH WEIGHT : 400kg

SEHİM LİMİTİ L/200 yada 15mm dir.

FARKLI RENKLİ EGRİSEL ÇİZGİLER, FARKLI RÜZGAR BASINCLARI ALTINDA, UYGULANABİLİR MAKSİMUM KANAT BOYUTLARINI GÖSTERİR.

ÜSTTEKİ TABLOYA GÖRE SEÇİLEN KANAT BOYUTU, CAM TEDARİKÇİSİNE BİLDİRİLEREK, İZİN VERİLEN BOYUT ve SEHİMİN, SEÇİLEN

CAMA UYGUN OLUP OLMADIĞI TEYİD EDİLMELİ ve ONAY ALINMALIDIR.

DİKKAT:

Bu statik hesap şeması ön yapısal hesaplamalar ve profil seçimi için tasarlanmıştır.

Bu şema nihai yapısal hesaplama için bir alternatif değildir, Statik Rapor olarak kullanılamaz

Statik Hesaplar Mutlaka Uygulamacı Tarafından Yapılmalıdır.

DEFLECTION LIMIT L / 200 or 15mm.

THE LINE SHOW MAXIMUM SIZES FOR THE INDICATE PRESSURE.

VERIFY THAT THE DEFLECTION OF THE SECTION IS COMPATIBLE WITH THE EMPLOYED GLASS.

DIN EN 12210 for the standard building area

Deflection limit L/200 or max. 15mm in accordance with TRLV

Differing deflection limits set by the double glazing manufacturer must be observed.

These statics diagram are intended for preliminary structural calculations and profile selection.

This is not a substitute for a final structural calculation.

Sash sizes below the line are structurally adequate.

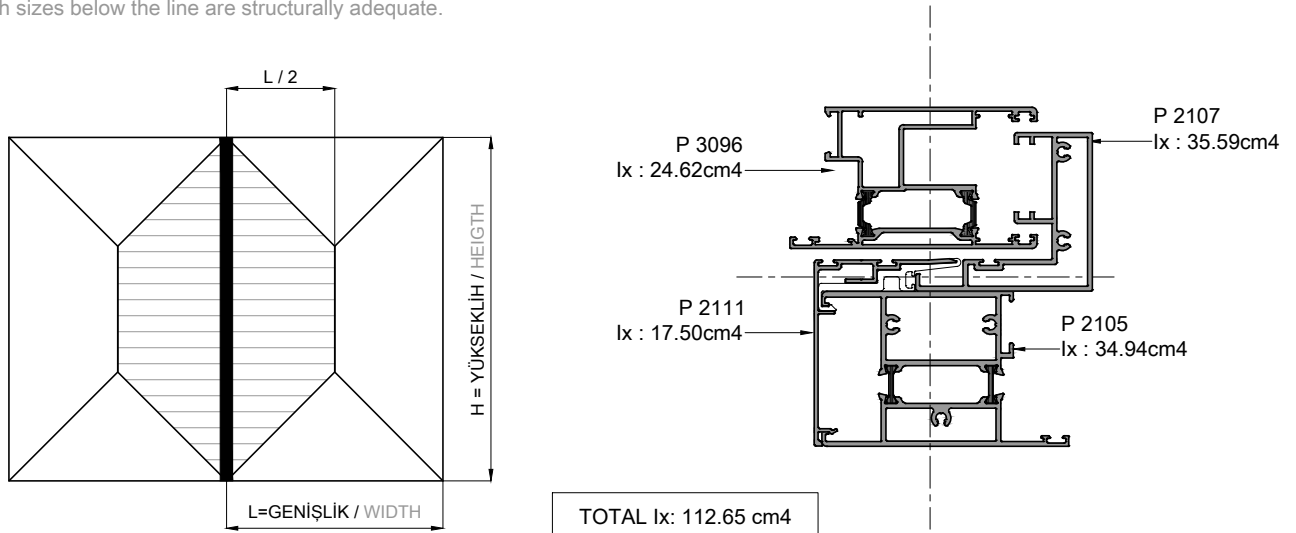

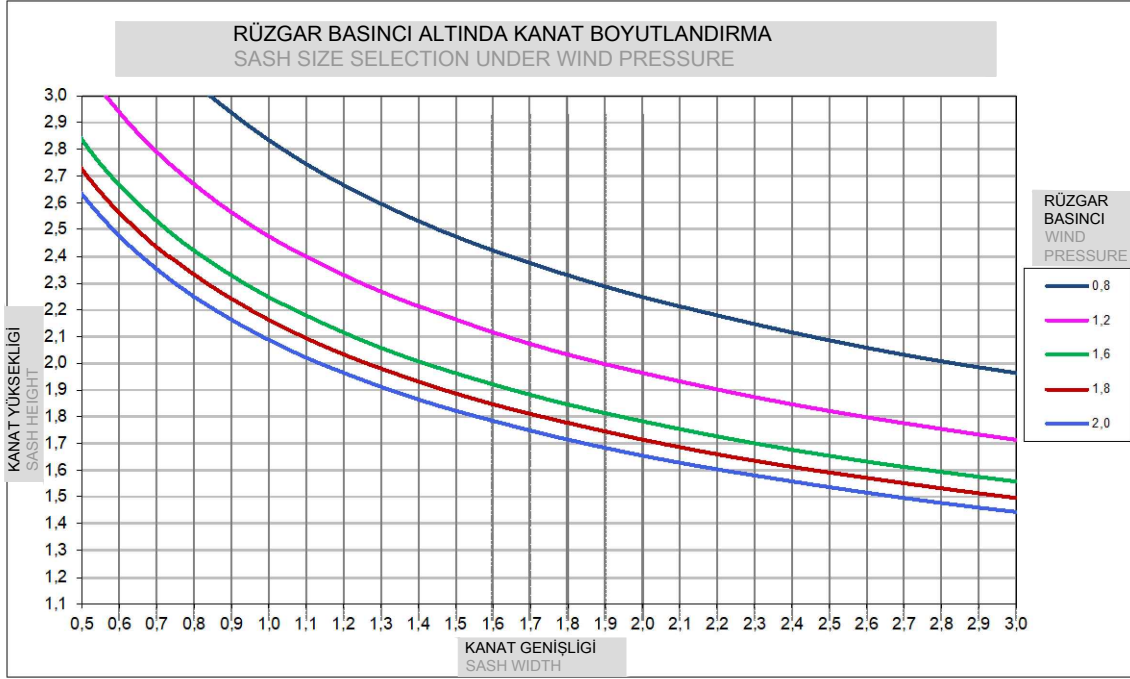

KANAT STATİK DİAGRAM
STATICAL DIAGRAM for SASH

KANAT AĞIRLIĞI : 400kg
SASH WEIGHT : 400kg

SEHİM LİMİTİ L/200 yada 15mm dir.

FARKLI RENKLİ EGRİSEL ÇİZGİLER, FARKLI RÜZGAR BASINCLARI ALTINDA, UYGULANABİLİR MAKSİMUM KANAT BOYUTLARINI GÖSTERİR.

ÜSTTEKİ TABLOYA GÖRE SEÇİLEN KANAT BOYUTU, CAM TEDARİKÇİSİNE BİLDİRİLEREK, İZİN VERİLEN BOYUT ve SEHİMİN, SEÇİLEN

CAMA UYGUN OLUP OLMADIĞI TEYİD EDİLMELİ ve ONAY ALINMALIDIR.

DİKKAT:

Bu statik hesap şeması ön yapısal hesaplamalar ve profil seçimi için tasarlanmıştır.

Bu şema nihai yapısal hesaplama için bir alternatif değildir, Statik Rapor olarak kullanılamaz.

Statik Hesaplar Mutlaka Uygulamacı Tarafından Yapılmalıdır.

DEFLECTION LIMIT L / 200 or 15mm.

THE LINE SHOW MAXIMUM SIZES FOR THE INDICATE PRESSURE.

VERIFY THAT THE DEFLECTION OF THE SECTION IS COMPATIBLE WITH THE EMPLOYED GLASS.

DIN EN 12210 for the standard building area

Deflection limit L/200 or max. 15mm in accordance with TRLV

Differing deflection limits set by the double glazing manufacturer must be observed.

These statics diagram are intended for preliminary structural calculations and profile selection.

This is not a substitute for a final structural calculation.

Sash sizes below the line are structurally adequate.

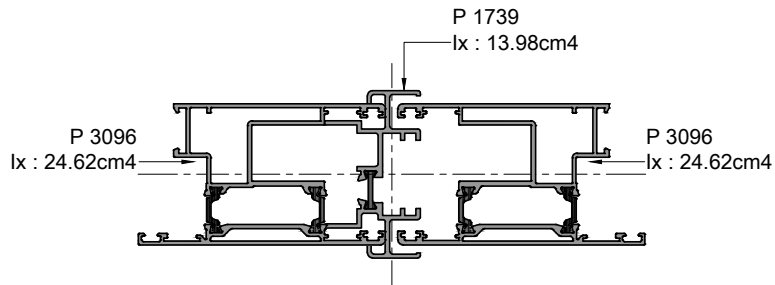
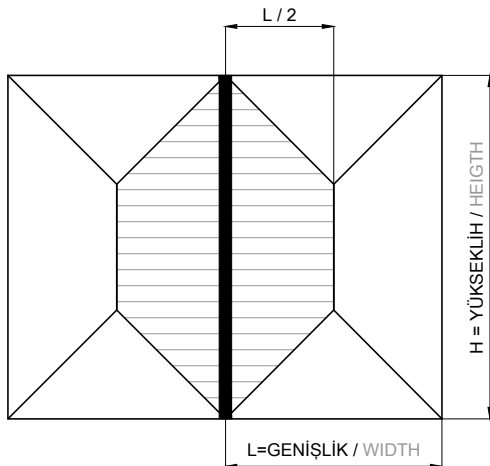

TOTAL Ix: 63.22 cm4

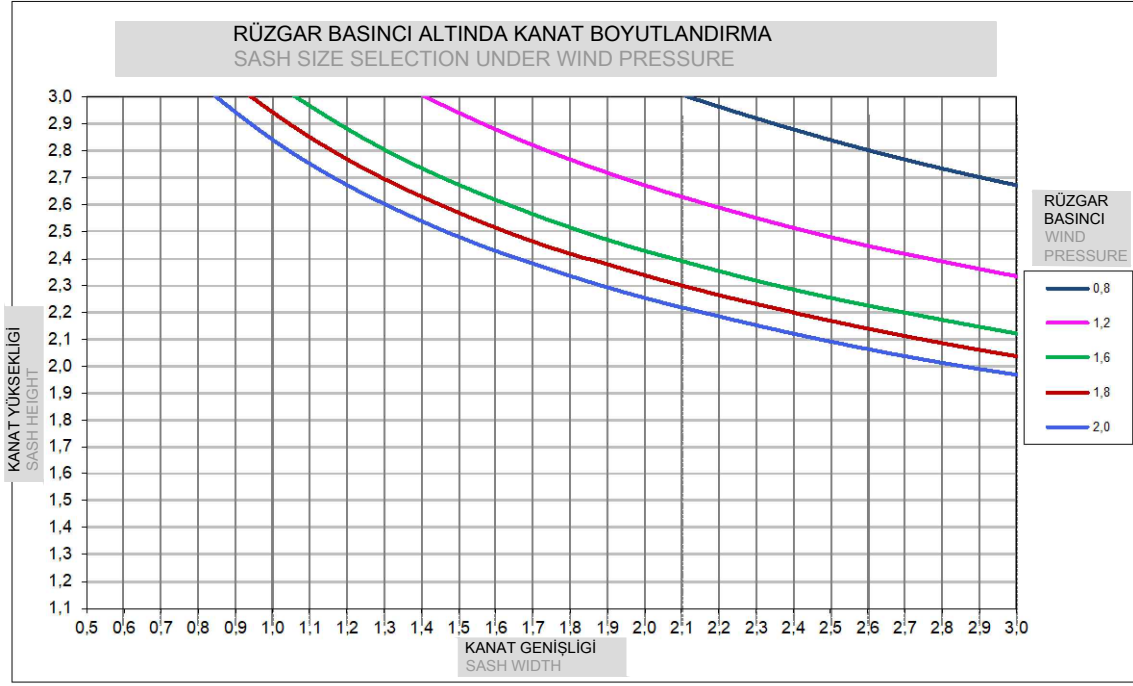

KANAT STATİK DİAGRAM
STATICAL DIAGRAM for SASH

KANAT AĞIRLIĞI : 400kg
SASH WEIGHT : 400kg

SEHİM LİMİTİ L/200 yada 15mm dir.

FARKLI RENKLİ EGRİSEL ÇİZGİLER, FARKLI RÜZGAR BASINCLARI ALTINDA, UYGULANABİLİR MAKSİMUM KANAT BOYUTLARINI GÖSTERİR.

ÜSTTEKİ TABLOYA GÖRE SEÇİLEN KANAT BOYUTU, CAM TEDARİKÇİSİNE BİLDİRİLEREK, İZİN VERİLEN BOYUT ve SEHİMİN, SEÇİLEN

CAMA UYGUN OLUP OLMADIĞI TEYİD EDİLMELİ ve ONAY ALINMALIDIR.

DİKKAT:

Bu statik hesap şeması ön yapısal hesaplamalar ve profil seçimi için tasarlanmıştır.

Bu şema nihai yapısal hesaplama için bir alternatif değildir, Statik Rapor olarak kullanılamaz

Statik Hesaplar Mutlaka Uygulamacı Tarafından Yapılmalıdır.

DEFLECTION LIMIT L / 200 or 15mm.

THE LINE SHOW MAXIMUM SIZES FOR THE INDICATE PRESSURE.

VERIFY THAT THE DEFLECTION OF THE SECTION IS COMPATIBLE WITH THE EMPLOYED GLASS.

DIN EN 12210 for the standard building area

Deflection limit L/200 or max. 15mm in accordance with TRLV

Differing deflection limits set by the double glazing manufacturer must be observed.

These statics diagram are intended for preliminary structural calculations and profile selection.

This is not a substitute for a final structural calculation.

Sash sizes below the line are structurally adequate.

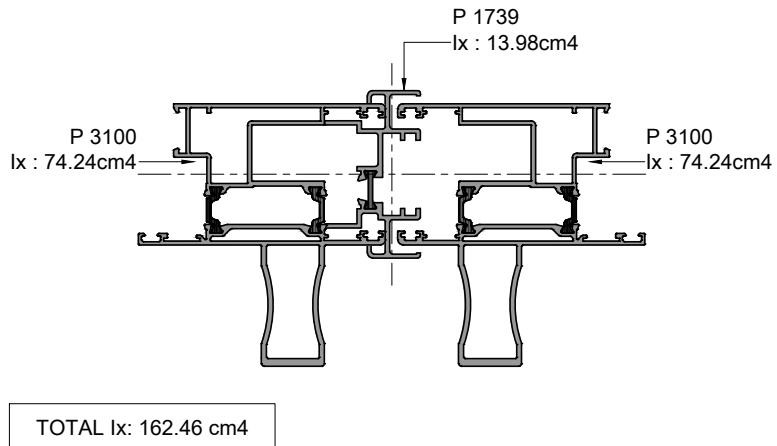
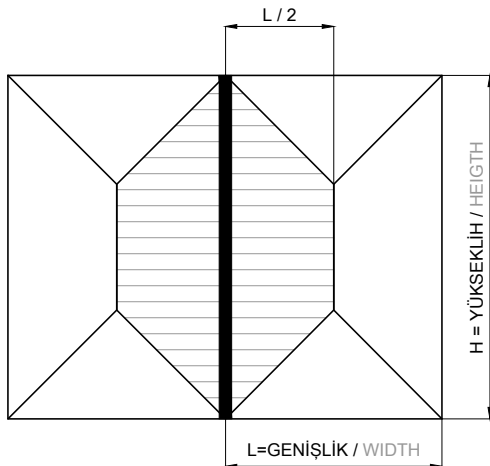

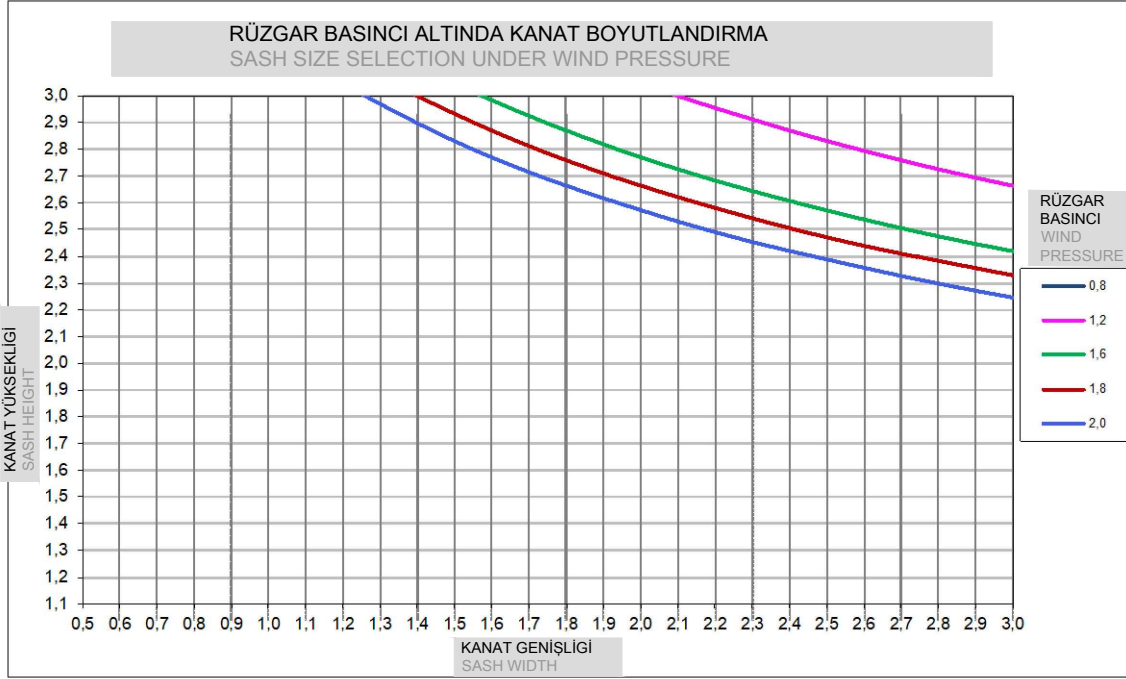

KANAT STATİK DİAGRAM
STATICAL DIAGRAM for SASH

KANAT AĞIRLIĞI : 400kg
SASH WEIGHT : 400kg

SEHİM LİMİTİ L/200 yada 15mm dir.

FARKLI RENKLİ EGRİSEL ÇİZGİLER, FARKLI RÜZGAR BASINCLARI ALTINDA, UYGULANABİLİR MAKSİMUM KANAT BOYUTLARINI GÖSTERİR.

ÜSTTEKİ TABLOYA GÖRE SEÇİLEN KANAT BOYUTU, CAM TEDARİKÇİSİNE BİLDİRİLEREK, İZİN VERİLEN BOYUT ve SEHİMİN, SEÇİLEN

CAMA UYGUN OLUP OLMADIĞI TEYİD EDİLMELİ ve ONAY ALINMALIDIR.

DİKKAT:

Bu statik hesap şeması ön yapısal hesaplamalar ve profil seçimi için tasarlanmıştır.

Bu şema nihai yapısal hesaplama için bir alternatif değildir, Statik Rapor olarak kullanılamaz

Statik Hesaplar Mutlaka Uygulamacı Tarafından Yapılmalıdır.

DEFLECTION LIMIT L / 200 or 15mm.

THE LINE SHOW MAXIMUM SIZES FOR THE INDICATE PRESSURE.

VERIFY THAT THE DEFLECTION OF THE SECTION IS COMPATIBLE WITH THE EMPLOYED GLASS.

DIN EN 12210 for the standard building area

Deflection limit L/200 or max. 15mm in accordance with TRLV

Differing deflection limits set by the double glazing manufacturer must be observed.

These statics diagram are intended for preliminary structural calculations and profile selection.

This is not a substitute for a final structural calculation.

Sash sizes below the line are structurally adequate.

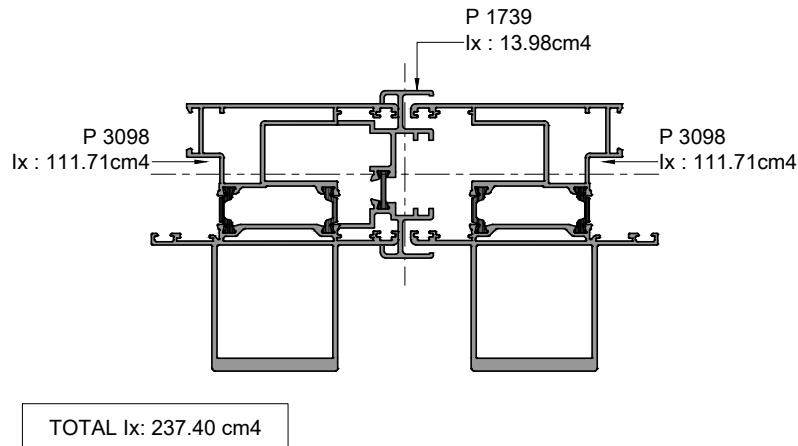
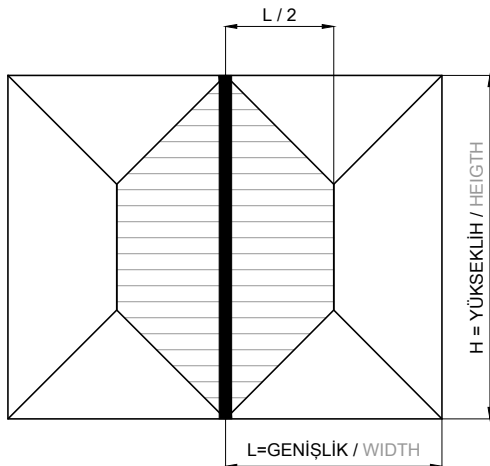

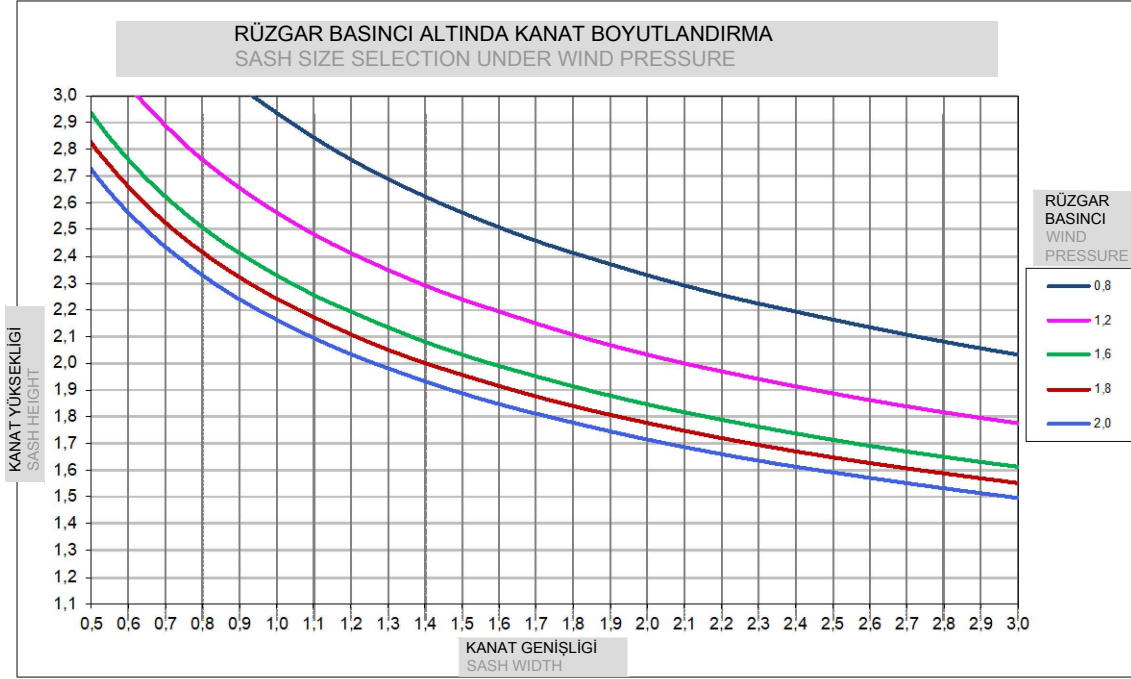

KANAT STATİK DİAGRAM
STATICAL DIAGRAM for SASH

KANAT AĞIRLIĞI : 400kg
SASH WEIGHT : 400kg

SEHİM LİMİTİ L/200 yada 15mm dir.

FARKLI RENKLİ EGRİSEL ÇİZGİLER, FARKLI RÜZGAR BASINCLARI ALTINDA, UYGULANABİLİR MAKSİMUM KANAT BOYUTLARINI GÖSTERİR.

ÜSTTEKİ TABLOYA GÖRE SEÇİLEN KANAT BOYUTU, CAM TEDARİKÇİSİNE BİLDİRİLEREK, İZİN VERİLEN BOYUT ve SEHİMİN, SEÇİLEN

CAMA UYGUN OLUP OLMADIĞI TEYİD EDİLMELİ ve ONAY ALINMALIDIR.

DİKKAT:

Bu statik hesap şeması ön yapısal hesaplamalar ve profil seçimi için tasarlanmıştır.

Bu şema nihai yapısal hesaplama için bir alternatif değildir, Statik Rapor olarak kullanılamaz

Statik Hesaplar Mutlaka Uygulamacı Tarafından Yapıtırılmalıdır.

DEFLECTION LIMIT L / 200 or 15mm.

THE LINE SHOW MAXIMUM SIZES FOR THE INDICATE PRESSURE.

VERIFY THAT THE DEFLECTION OF THE SECTION IS COMPATIBLE WITH THE EMPLOYED GLASS.

DIN EN 12210 for the standard building area

Deflection limit L/200 or max. 15mm in accordance with TRLV

Differing deflection limits set by the double glazing manufacturer must be observed.

These statics diagram are intended for preliminary structural calculations and profile selection.

This is not a substitute for a final structural calculation.

Sash sizes below the line are structurally adequate.

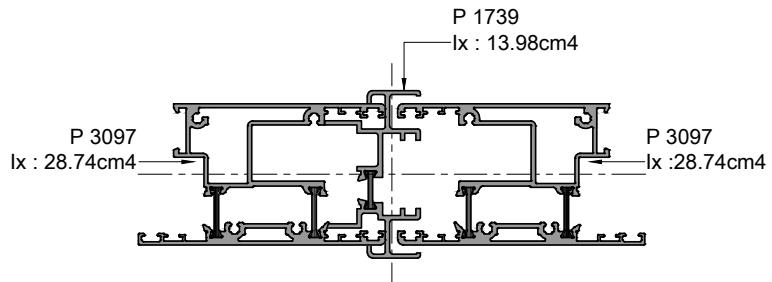
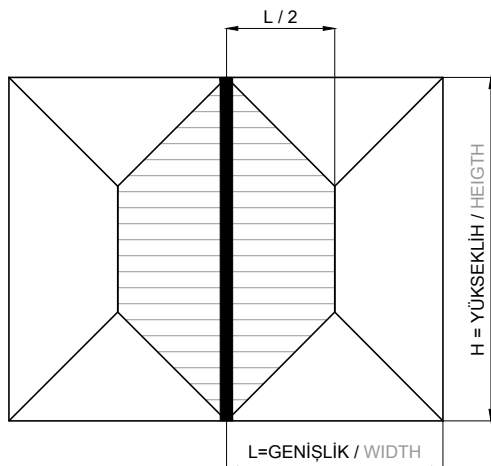

TOTAL Ix : 71.46 cm4

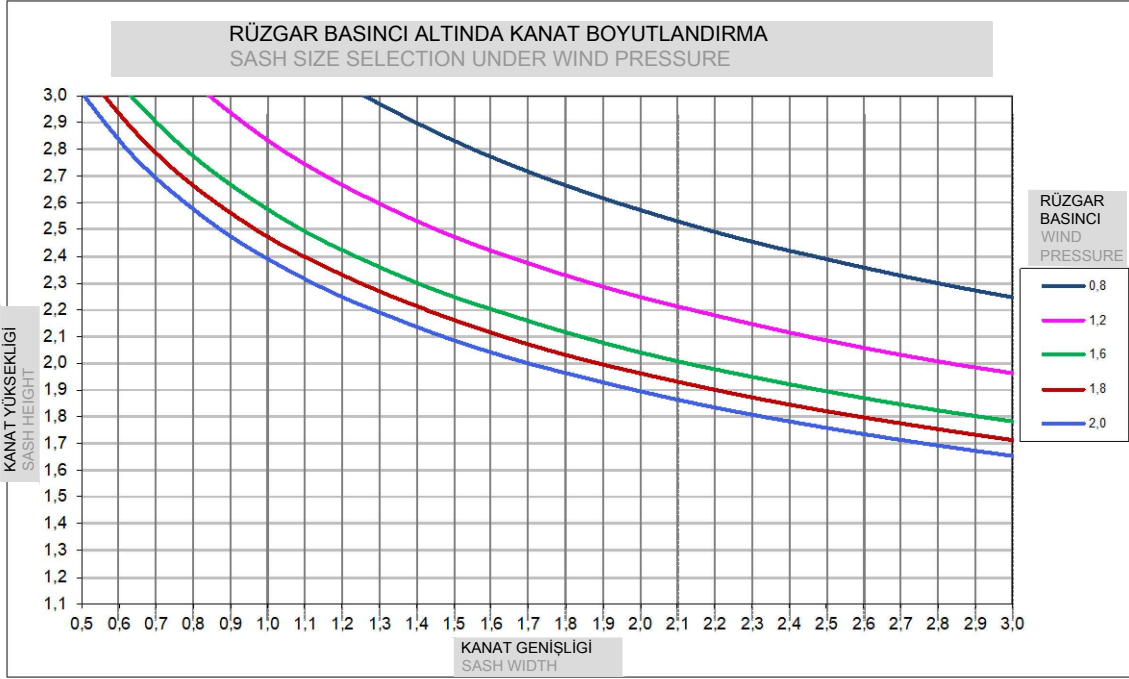

KANAT STATİK DİAGRAM
STATICAL DIAGRAM for SASH

KANAT AĞIRLIĞI : 400kg
SASH WEIGHT : 400kg

SEHİM LİMİTİ L/200 yada 15mm dir.

FARKLI RENKLİ EGRİSEL ÇİZGİLER, FARKLI RÜZGAR BASINCLARI ALTINDA, UYGULANABİLİR MAKSİMUM KANAT BOYUTLARINI GÖSTERİR.

ÜSTTEKİ TABLOYA GÖRE SEÇİLEN KANAT BOYUTU, CAM TEDARİKÇİSİNE BİLDİRİLEREK, İZİN VERİLEN BOYUT ve SEHİMİN, SEÇİLEN

CAMA UYGUN OLUP OLMADIĞI TEYİD EDİLMELİ ve ONAY ALINMALIDIR.

DİKKAT:

Bu statik hesap şeması ön yapısal hesaplamalar ve profil seçimi için tasarlanmıştır.

Bu şema nihai yapısal hesaplama için bir alternatif değildir, Statik Rapor olarak kullanılmaz.

Statik Hesaplar Mutlaka Uygulamacı Tarafından Yapılmalıdır.

DEFLECTION LIMIT L / 200 or 15mm.

THE LINE SHOW MAXIMUM SIZES FOR THE INDICATE PRESSURE.

VERIFY THAT THE DEFLECTION OF THE SECTION IS COMPATIBLE WITH THE EMPLOYED GLASS.

DIN EN 12210 for the standard building area

Deflection limit L/200 or max. 15mm in accordance with TRLV

Differing deflection limits set by the double glazing manufacturer must be observed.

These statics diagram are intended for preliminary structural calculations and profile selection.

This is not a substitute for a final structural calculation.

Sash sizes below the line are structurally adequate.

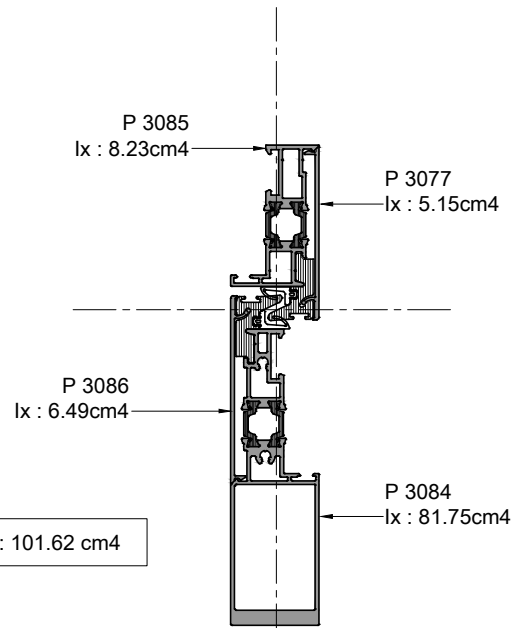
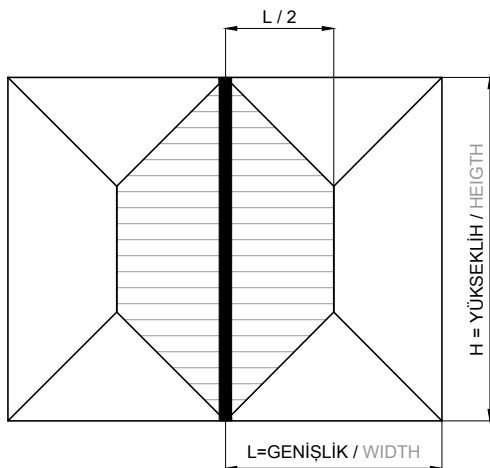

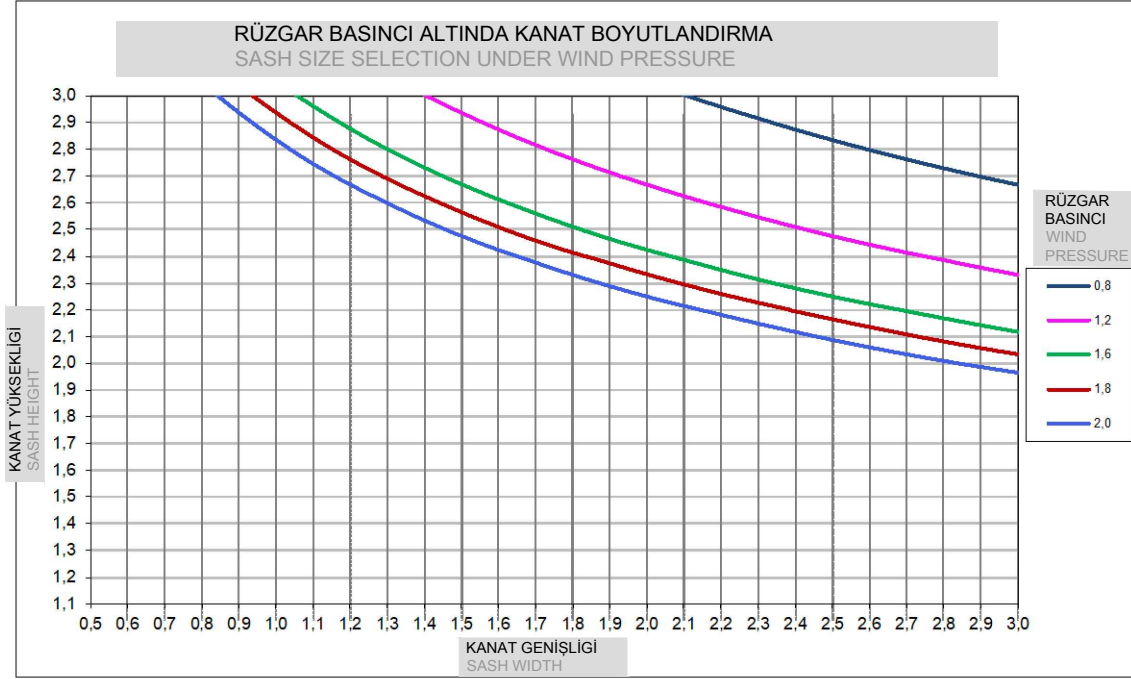

KANAT STATİK DİAGRAM
STATICAL DIAGRAM for SASH

KANAT AĞIRLIĞI : 400kg
SASH WEIGHT : 400kg

SEHİM LİMİTİ L/200 yada 15mm dir.

FARKLI RENKLİ EGRİSEL ÇİZGİLER, FARKLI RÜZGAR BASINCLARI ALTINDA, UYGULANABİLİR MAKSİMUM KANAT BOYUTLARINI GÖSTERİR.

ÜSTTEKİ TABLOYA GÖRE SEÇİLEN KANAT BOYUTU, CAM TEDARİKÇİSİNE BİLDİRİLEREK, İZİN VERİLEN BOYUT ve SEHİMİN, SEÇİLEN

CAMA UYGUN OLUP OLMADIĞI TEYİD EDİLMELİ ve ONAY ALINMALIDIR.

DİKKAT:

Bu statik hesap şeması ön yapısal hesaplamalar ve profil seçimi için tasarlanmıştır.

Bu şema nihai yapısal hesaplama için bir alternatif değildir, Statik Rapor olarak kullanılamaz

Statik Hesaplar Mutlaka Uygulamacı Tarafından Yapılmalıdır.

DEFLECTION LIMIT L / 200 or 15mm.

THE LINE SHOW MAXIMUM SIZES FOR THE INDICATE PRESSURE.

VERIFY THAT THE DEFLECTION OF THE SECTION IS COMPATIBLE WITH THE EMPLOYED GLASS.

DIN EN 12210 for the standard building area

Deflection limit L/200 or max. 15mm in accordance with TRLV

Differing deflection limits set by the double glazing manufacturer must be observed.

These statics diagram are intended for preliminary structural calculations and profile selection.

This is not a substitute for a final structural calculation.

Sash sizes below the line are structurally adequate.

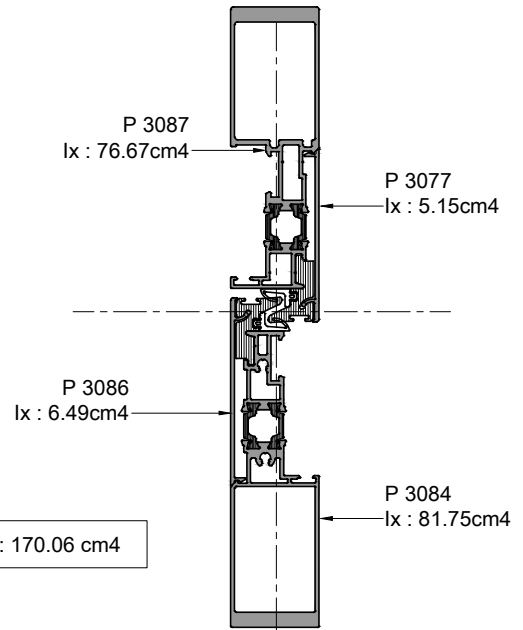
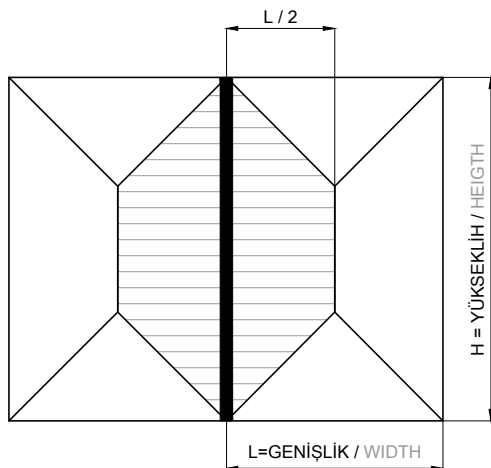

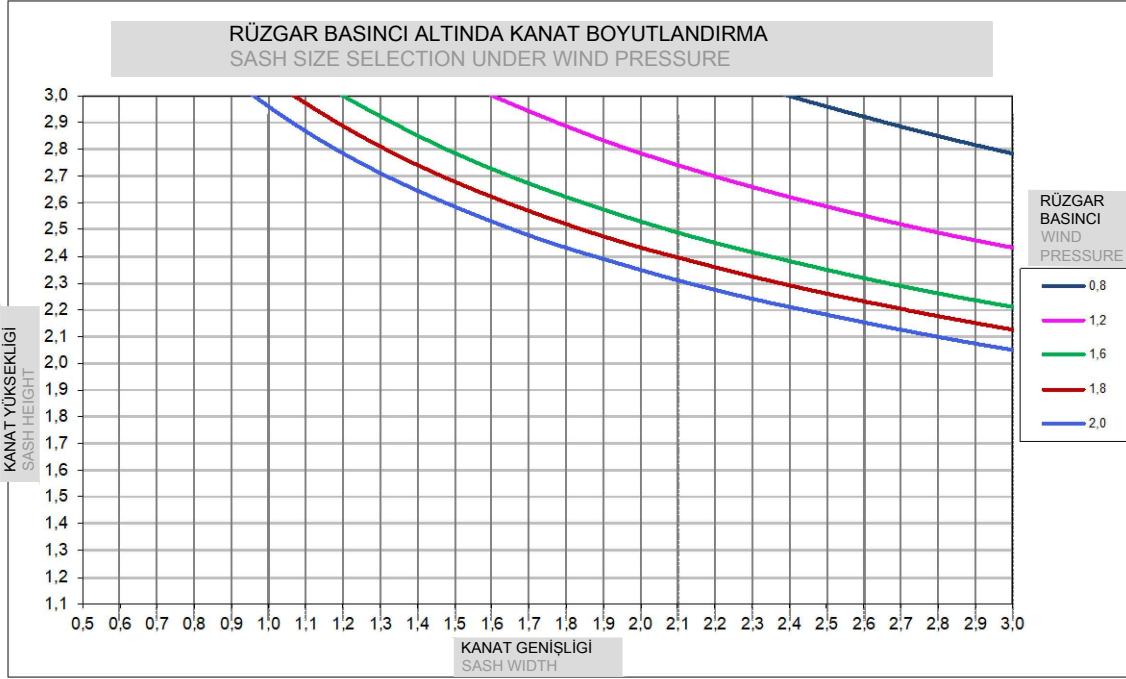

KANAT STATİK DİAGRAM
STATICAL DIAGRAM for SASH

KANAT AĞIRLIĞI : 400kg
SASH WEIGHT : 400kg

SEHİM LİMİTİ L/200 yada 15mm dir.

FARKLI RENKLİ EGRİSEL ÇİZGİLER, FARKLI RÜZGAR BASINCLARI ALTINDA, UYGULANABİLİR MAKSİMUM KANAT BOYUTLARINI GÖSTERİR.

ÜSTTEKİ TABLOYA GÖRE SEÇİLEN KANAT BOYUTU, CAM TEDARİKÇİSİNE BİLDİRİLEREK, İZİN VERİLEN BOYUT ve SEHİMİN, SEÇİLEN

CAMA UYGUN OLUP OLMADIĞI TEYİD EDİLMELİ ve ONAY ALINMALIDIR.

DİKKAT:

Bu statik hesap şeması ön yapısal hesaplamalar ve profil seçimi için tasarlanmıştır.

Bu şema nihai yapısal hesaplama için bir alternatif değildir, Statik Rapor olarak kullanılamaz

Statik Hesaplar Mutlaka Uygulamacı Tarafından Yapılmalıdır.

DEFLECTION LIMIT L / 200 or 15mm.

THE LINE SHOW MAXIMUM SIZES FOR THE INDICATE PRESSURE.

VERIFY THAT THE DEFLECTION OF THE SECTION IS COMPATIBLE WITH THE EMPLOYED GLASS.

DIN EN 12210 for the standard building area

Deflection limit L/200 or max. 15mm in accordance with TRLV

Differing deflection limits set by the double glazing manufacturer must be observed.

These statics diagram are intended for preliminary structural calculations and profile selection.

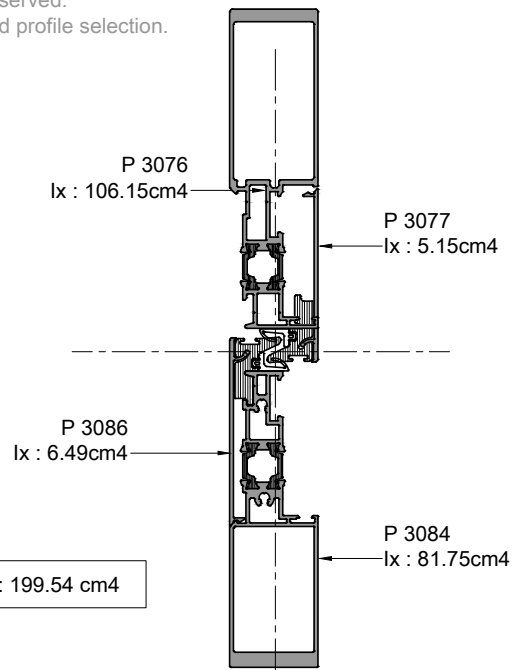
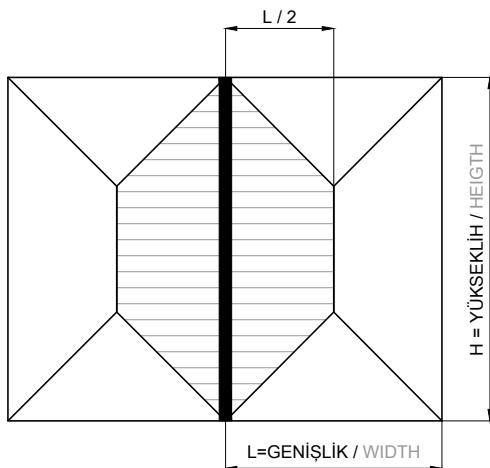

This is not a substitute for a final structural calculation.

Sash sizes below the line are structurally adequate.





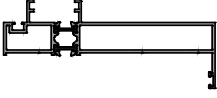
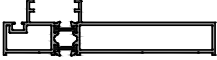
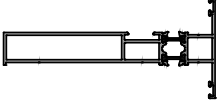

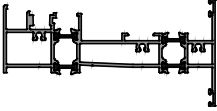
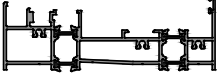
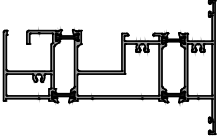
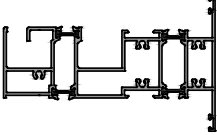
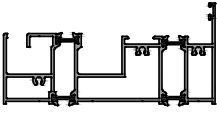
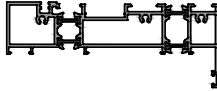

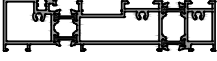
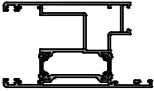
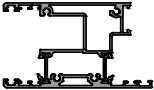
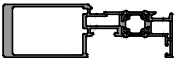
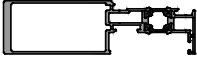
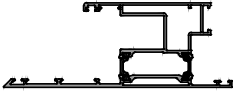
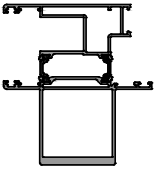
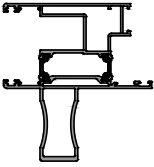

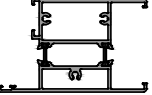
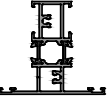
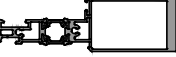

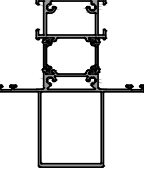
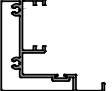



UNIQUEslideMS
KALDIR ve SÜR KAPI SİSTEMİ
LIFT&SLIDE DOOR SYSTEM





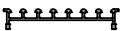

ALUMİNYUM PROFİLLER
ALUMINIUM PROFILES







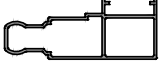
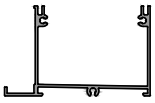
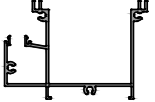



PROFİL ŞEKLİ PROFILE SECTION	PROFİL ADI PROFILE NO	KALIP KODU DIE NO	PROFİL TANIMI PROFILE DESCRIPTION	AĞIRLIK WEIGHT
	P 2101	17529 + 17530	YAN KASA PROFİLİ side frame profile	2.265kg/mt
	P 2397	17529 + 18876	YAN KASA PROFİLİ side frame profile	2.140kg/mt
	P 2102	17527 + 17528	YAN KASA PROFİLİ side frame profile	2.250kg/mt
	P 2398	17527 + 18875	YAN KASA PROFİLİ side frame profile	2.125kg/mt
	P 2103	17534 17535 17536	ALT KASA PROFİLİ bottom frame profile	3.155kg/mt
	P 2399	17534 17535 18881	ALT KASA PROFİLİ bottom frame profile	3.035kg/mt
	P 2104	17531 17532 17533	ÜST KASA PROFİLİ top frame profile	3.645kg/mt
	P 2401	17531 18878 18877	ÜST KASA PROFİLİ top frame profile	3.830kg/mt
	P 2400	17531 17532 18879	ÜST KASA PROFİLİ top frame profile	3.520kg/mt
	P 3095	20050 9500 9498	SIFIR EŞİK KASA PROFİLİ flat sill bottom frame profile	3.020kg/mt







PROFİL ŞEKLİ PROFILE SECTION	PROFİL ADI PROFILE NO	KALIP KODU DIE NO	PROFİL TANIMI PROFILE DESCRIPTION	AĞIRLIK WEIGHT
	P 3094	20050 9500 9499	SIFIR EŞİK KASA PROFİLİ flat sill bottom frame profile	2.910kg/mt
	P 3096	* + 16405	KANAT PROFİLİ sash profile	2.075kg/mt
	P 3065	* + 19836	KANAT PROFİLİ sash profile 35mm kenet ile kullanılır using with 35 mm interlock	2.300kg/mt
	P 3087	- + 20093	35 mm TAKVİYELİ KENET PROFİLİ 35mm interlock with reinforcement	2.030kg/mt
	P 3076	20095 + 20093	35 mm TAKVİYELİ KENET PROFİLİ 35mm interlock with reinforcement	2.070kg/mt
	P 3099	* + 17031	KÖŞE KANAT PROFİLİ corner sash profile	2.480kg/mt
	P 3098	* + 18643	TAKVİYELİ KANAT PROFİLİ sash profile with reinforcement	3.240kg/mt
	P 3100	* + 17526	TAKVİYELİ KANAT PROFİLİ sash profile with reinforcement	2.775kg/mt

PROFİL ŞEKLİ PROFILE SECTION	PROFİL ADI PROFILE NO	KALIP KODU DIE NO	PROFİL TANIMI PROFILE DESCRIPTION	AĞIRLIK WEIGHT
	P 3085	9542 + 20093	İNCE KANAT PROFİLİ Slim sash profile	0.940kg/mt
	P 2105	17537 + 17538	ORTA KAYIT PROFİLİ mullion profile	2.440kg/mt
	P 2402	18880 + 17536	ORTA KAYIT PROFİLİ mullion profile	1.605kg/mt
	P 3084	9501 + 9543	35mm DIŞTAN TAKVİYELİ ORTA KAYIT PROFİLİ 35mm exterior interlock mullion profile with reinforcement	2.060kg/mt
	P 3088	9501 + -	ORTA KAYIT PROFİLİ mullion profile	1.100kg/mt
	P 1753	17066 + 17065	ORTA KAYIT PROFİLİ mullion profile	2.580kg/mt
	P 2107	17539	ADAPTÖR PROFİLİ adepter profile	1,590kg/mt
	P 1739	16408 + 16409	ÇİFT KANAT ADAPTÖR PROFİLİ double sash adapter profile	1.035kg/mt
	P 2108	17542	KAPAK PROFİLİ cap profile	0.590kg/mt

PROFİL ŞEKLİ PROFILE SECTION	PROFİL ADI PROFILE NO	KALIP KODU DIE NO	PROFİL TANIMI PROFILE DESCRIPTION	AĞIRLIK WEIGHT
	P 3091	9540	KAPATMA PROFİLİ Closing Profile	0.175kg/mt
	P 3086	9538	KAPATMA PROFİLİ Closing Profile	0.340kg/mt
	P 3103	20278	KAPATMA PROFİLİ Closing Profile	0.370kg/mt
	P 3077	20096	KAPATMA PROFİLİ Closing Profile	0.315kg/mt
	P 2111	19180	KASA KAPATMA PROFİLİ frame closing profile	0.681kg/mt
	P 2110	19181	KANAT KAPATMA PROFİLİ sash closing profile	0.660kg/mt
	P 2109	17834	KAPATMA PROFİLİ (opsiyonel) closing profile(optional)	0.155kg/mt
	P 2327	18838	ÜST IZGARA PROFİLİ top grille profile	0.635kg/mt
	P 3067	9344	CAM ÇITA PROFİLİ glazing bead profile	0.235kg/mt
	P 1750	12558	CAM ÇITA PROFİLİ glazing bead profile	0.280kg/mt

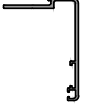
PROFİL ŞEKLİ PROFILE SECTION	PROFİL ADI PROFILE NO	KALIP KODU DIE NO	PROFİL TANIMI PROFILE DESCRIPTION	AĞIRLIK WEIGHT
	P 1745	16410	CAM ÇITA PROFİLİ glazing bead profile	0.270kg/mt
	P 1746	16411	CAM ÇITA PROFİLİ glazing bead profile	0.275kg/mt
	P 1747	16412	CAM ÇITA PROFİLİ glazing bead profile	0.280kg/mt
	P 1748	16413	CAM ÇITA PROFİLİ glazing bead profile	0.300kg/mt
	P 1749	16414	CAM ÇITA PROFİLİ glazing bead profile	0.340kg/mt
	P 1752	17032	KİLİTLEME ADAPTÖR PROFİLİ locking adapter profile	1.565kg/mt
	P 2467	19409	SU KANALI PROFİLİ Water channel Profile	1.295kg/mt
	P 2328	18839	SU KANALI PROFİLİ Water channel Profile	1.530kg/mt
	P 3093	*	SU KANALI EK PROFİLİ water channel additional profile	0.210kg/mt
	P 3092	9541	CAM ÇITA PROFİLİ glazing bead profile	0.205kg/mt

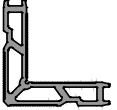
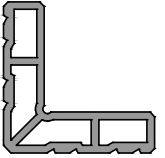
PROFİL ŞEKLİ PROFILE SECTION	PROFİL ADI PROFILE NO	KALIP KODU DIE NO	PROFİL TANIMI PROFILE DESCRIPTION	AĞIRLIK WEIGHT
	P 1740	16400	RAY PROFİLİ rail profile	0.180kg/mt
	P 2488	19678	RAY PROFİLİ Rail Profile	0.170kg/mt
	P 3072	20056	YÜKSEK RAY PROFİLİ High rail profile	0.500kg/mt
	P 3079	-	5mm CAM ÇITA PROFİLİ 5mm glazing bead profile	0.160kg/mt
	P 3080	9544	12mm CAM ÇITA PROFİLİ 12mm glazing bead profile	0.195kg/mt
	P 3078	20097	15.5mm CAM ÇITA PROFİLİ 15.5mm glazing bead profile	0.225kg/mt
	P 3081	-	19mm CAM ÇITA PROFİLİ 19mm glazing bead profile	0.240kg/mt
	P 3082	-	26mm CAM ÇITA PROFİLİ 26mm glazing bead profile	0.245kg/mt
	P 3083	-	33mm CAM ÇITA PROFİLİ 33mm glazing bead profile	0.270kg/mt
	P 2205	19336	40mm PERVAZ PROFİLİ 40mm architrave profile	0.340kg/mt

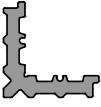
PROFİL ŞEKLİ PROFILE SECTION	PROFİL ADI PROFILE NO	KALIP KODU DIE NO	PROFİL TANIMI PROFILE DESCRIPTION	AĞIRLIK WEIGHT
	P 1177	12917	40mm PERVAZ PROFİLİ 40mm architrave profile	0.300kg/mt
	P 1178	13250	50mm PERVAZ PROFİLİ 50mm architrave profile	0.375kg/mt
	P 1287	11214	42mm ÇİZGİLİ PERVAZ PROFİLİ 42mm architrave profile with lines	0.360kg/mt
	P 1222	12795	68mm PERVAZ PROFİLİ 68mm architrave profile	0.760kg/mt
	P 1321	13178	20mm PERVAZ PROFİLİ 20mm architrave profile	0.160kg/mt
	P 1761	16210	40mm UZUN PERVAZ PROFİLİ 40mm long architrave profile	0.890kg/mt
	P 2158	5541	KÖŞE TAKOZ PROFİLİ corner cleat profile	2.550kg/mt
	P 1070	339	KÖŞE TAKOZ PROFİLİ corner cleat profile	6.220kg/mt
	P 1016	12254	KÖŞE TAKOZ PROFİLİ corner cleat profile	4.910kg/mt
	P 1117	10781	KÖŞE TAKOZ PROFİLİ corner cleat profile	3.035kg/mt

UNIQUEslideMS
KALDIR ve SÜR KAPI SİSTEMİ
LIFT&SLIDE DOOR SYSTEM

CAM MONTAJ TALİMATI
GLAZING ASSEMBLY

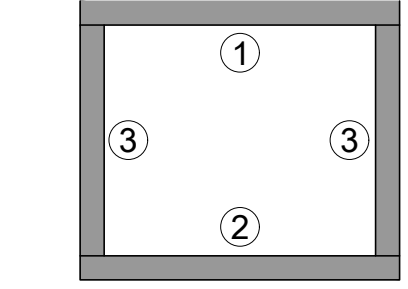
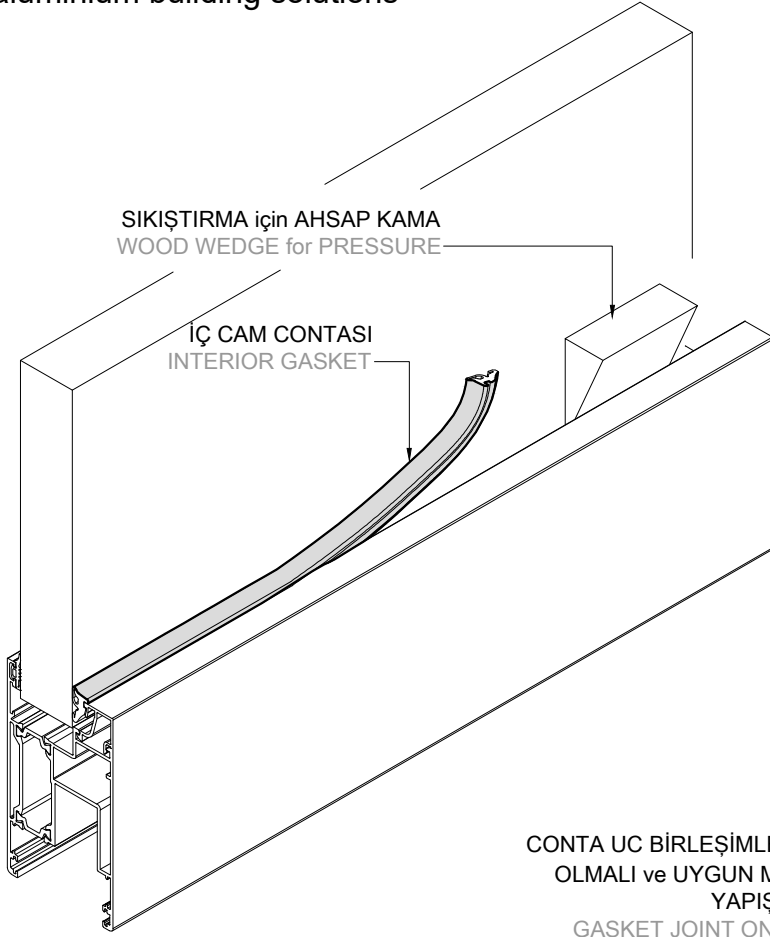

CAM ÇITASI MONTAJ SIRALAMASI
GLAZING BEAD ASSEMBLY SEQUENC

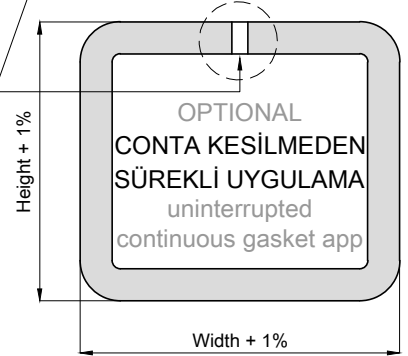
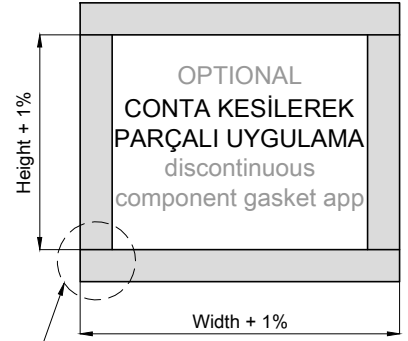

CONTA UC BİRLEŞİMLERİ ÜSTTE
OLMALI ve UYGUN MASTİK İLE
YAPIŞTIRILMALI
GASKET JOINT ON THE TOP,
BOND WITH EPDM GLUE.

1 CAM TAKOZU

Cam takozları yerlesimi altta bulunan sematik çizimde gösterilmiştir.
takozların kenara mesafeleri kanat ölçüsünün 5/1 i yada 10/1 i kadar olmalıdır.
GLASS CLEATS

The assembly of glass reinforcement pieces has been showed at the top schematically. The gap distance to the corner should be, the 5/1 or 10/1 of the sash size.

2 MESAFE AYARLAMA TAKOZU

Mesafe ayar takozları camın alüminyum çerçeve içinde doğru pozisyonda stabil olarak durmasını sağlar.
cam ile profil arasına takozları zorlamadan yerleştiriniz.

DISTANCE ADJUSTMENT PIECE

Distance adjustment pieces stabilize the glass in the frame at the true position. Put the distance adjustment piece between glass and profile without using force.

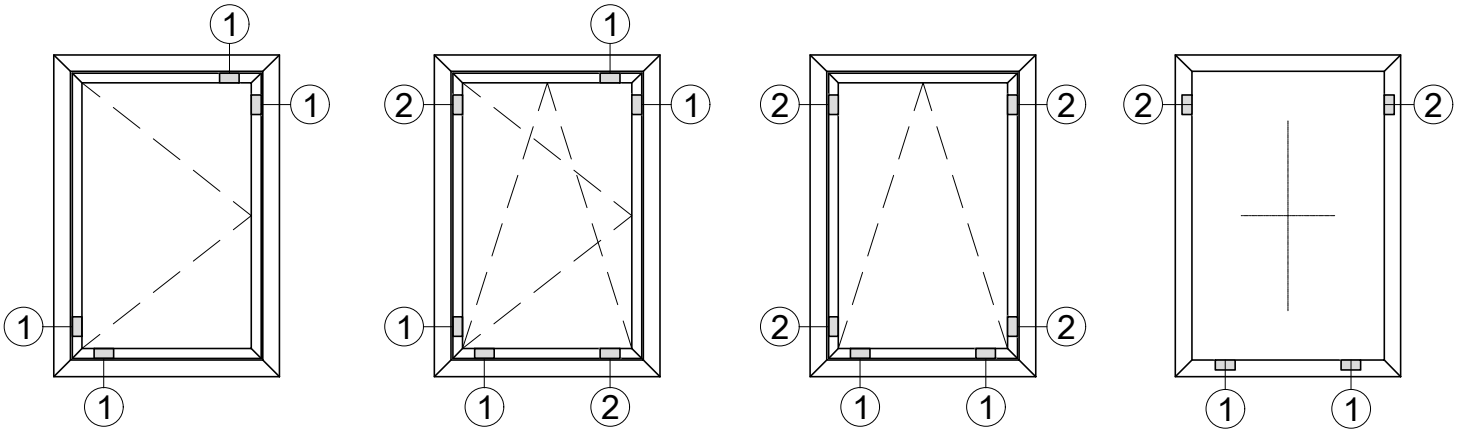























AKSESUAR ve DONANIM MONTAJINDAN ÖNCE,
CAM ve TAKOZLAMA İŞLEMİ YAPILMALIDIR.

THE PANE MUST BE SHIMMED IN THE SASH SO THAT THE SASH OPERATES WITHOUT ADJUSTMENT OF THE HARDWARE.

1 TAŞIYICI TAKOZ
GLASS CLEAT

2 AYAR TAKOZU
ADJUSTMENT PIECE

CAM KALINLIĞI glass thickness	ÇITA glazing bead		CAM CONTASI glazing gasket	
	profil section	kod code	perdeli conta with fin gasket	standart conta without fin gasket
10mm	P 3083 (33mm) 33		 800 271 (6mm)	
12mm			 800 228 (4mm)	
14mm	P 3082 (26mm) 26		 800 278 (10mm)	
16mm			 800 277 (8mm)	
18mm			 800 271 (6mm)	
20mm	P 3081 (19mm) 19		 800 278 (10mm)	
22mm			 800 277 (8mm)	
24mm			 800 271 (6mm)	
26mm	P 3078 (15.5mm) 15.5		 800 277 (8mm)	
28mm			 800 271 (6mm)	
30mm	P 3080 (12mm) 12		 800 277 (8mm)	
32mm			 800 271 (6mm)	
34mm	P 3079 (5mm) 5		 800 278 (10mm)	
36mm			 800 277 (8mm)	
38mm			 800 271 (6mm)	
40mm			 800 228 (4mm)	

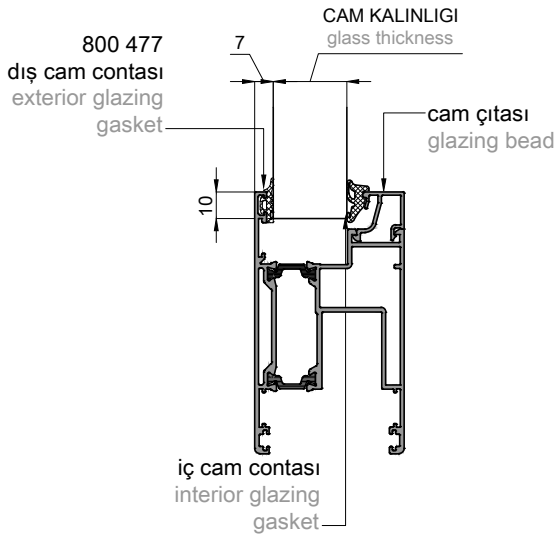





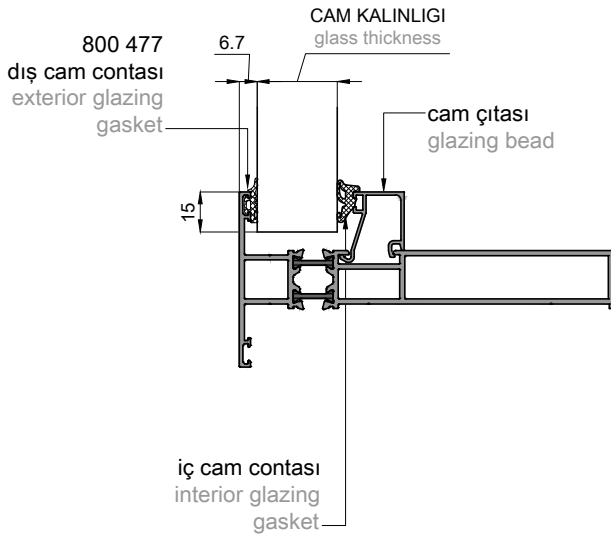

















Yanda tablodaki veriler teoriktir.
Lütfen cam ve conta toleranslarını dikkate alınız.
selection tables promise a first planning.
Please keep the glass and gasket tolerances in mind.

CAM KALINLIĞI glass thickness	ÇITA glazing bead		CAM CONTASI glazing gasket	
	profil section	kod code	perdeli conta with fin gasket	standart conta without fin gasket
16mm	P 1749 (33mm) 33			800 271 (6mm)
18mm				800 228 (4mm)
20mm	P 1748 (26mm) 26			800 278 (10mm)
22mm				800 277 (8mm)
24mm				800 271 (6mm)
26mm	P 1747 (19mm) 19			800 278 (10mm)
28mm				800 277 (8mm)
30mm				800 271 (6mm)
32mm	P 1746 (15.5mm) 15.5			800 277 (8mm)
34mm				800 271 (6mm)
36mm	P 1745 (12mm) 12			800 277 (8mm)
38mm				800 271 (6mm)
40mm	P 1750 (5mm) 5			800 278 (10mm)
42mm				800 277 (8mm)
44mm				800 271 (6mm)
46mm				800 228 (4mm)



Yanda tablodaki veriler teoriktir.
Lütfen cam ve conta toleranslarını dikkate alınız.
selection tables promise a first planning.
Please keep the glass and gasket tolerances in mind.



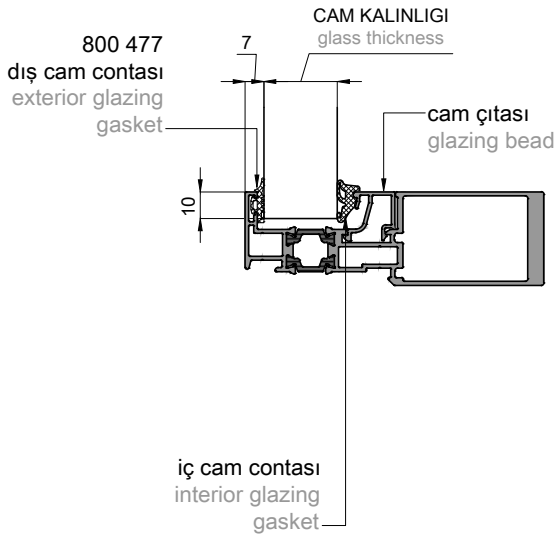







CAM KALINLIĞI glass thickness	ÇITA glazing bead		CAM CONTASI glazing gasket
	profil section	kod code	standart conta without fin gasket
10mm	P 3083 (33mm) 33 		 800 271 (6mm)
12mm			 800 228 (4mm)
14mm	P 3082 (26mm) 26 		 800 278 (10mm)
16mm			 800 277 (8mm)
18mm			 800 271 (6mm)
20mm	P 3081 (19mm) 19 		 800 278 (10mm)
22mm			 800 277 (8mm)
24mm			 800 271 (6mm)
26mm	P 3078 (15.5mm) 15.5 		 800 277 (8mm)
28mm			 800 271 (6mm)
30mm	P 3080 (12mm) 12 		 800 277 (8mm)
32mm			 800 271 (6mm)
34mm	P 3079 (5mm) 5 		 800 278 (10mm)
36mm			 800 277 (8mm)
38mm			 800 271 (6mm)
40mm			 800 228 (4mm)



Yanda tablodaki veriler teoriktir.
Lütfen cam ve conta toleranslarını dikkate alınız.
selection tables promise a first planning.
Please keep the glass and gasket tolerances in mind.

UNIQUEslide**MS**
KALDIR ve SÜR KAPI SİSTEMİ
LIFT&SLIDE DOOR SYSTEM







CONTALAR
GASKETS





CONTA ŞEKLİ GASKET SECTION	CONTA KODU GASKET NO	MALZEME MATERIAL	CONTA TANIMI GASKET DESCRIPTION	PAKET PACKAGE
	800 228	EPDM	4mm İÇ CAM CONTASI interior glazing gasket 4mm	200mt/pk 0,075kg/mt
	800 271	EPDM	6mm İÇ CAM CONTASI interior glazing gasket 6mm	192mt/pk 0,078kg/mt
	800 277	EPDM	8mm İÇ CAM CONTASI interior glazing gasket 8mm	150mt/pk 0,100kg/mt
	800 278	EPDM	10mm İÇ CAM CONTASI interior glazing gasket 10mm	120mt/pk 0,125kg/mt
	800 490	EPDM	KENET SIZDIRMAZLIK CONTASI interlock gasket	355mt/pk 0,028kg/mt
	800 259	FİRÇA	PERDELİ FIRÇA FİTİL brush gasket with fin	275mt/pk 2x275mt
	800 459	EPDM	KASA KANAL KAPATMA CONTASI closing gasket for frame	140mt/pk 0,108kg/mt
	800 470	EPDM	KANAT ÜST CONTASI sash top gasket	323mt/pk 0,031kg/mt
	800 472	EPDM	KASA KANAL KAPATMA CONTASI closing gasket for frame	183mt/pk 0,082kg/mt
	800 475	EPDM	KASA DÜŞEY BİNİ CONTASI vertical overlap gasket for frame	333mt/pk 0,045kg/mt

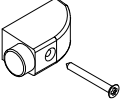
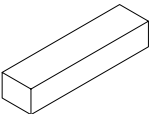
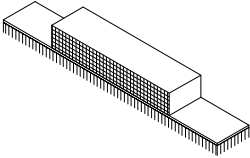

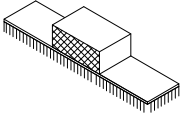

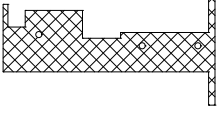
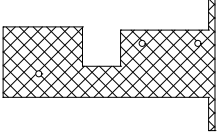
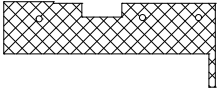
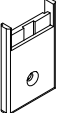
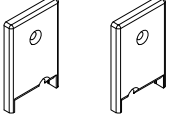

CONTA ŞEKLİ GASKET SECTION	CONTA KODU GASKET NO	MALZEME MATERIAL	CONTA TANIMI GASKET DESCRIPTION	PAKET PACKAGE
	800 477	EPDM	DIŞ CAM CONTASI ekterior glazing gasket	300mt/pk 0,050kg/mt
	800 476	EPDM	ÇİFT KANAT BİNİ CONTASI overlap gasket for double sash	236mt/pk 0,055kg/mt
	800 471	EPDM	KANAT ALT ve YAN CONTASI sash bottom and side gasket	405/pk 0,037kg/mt
	800 480	EPDM	KAPAK CONTASI frame cap gasket	435mt/pk 0,023kg/mt
	801 302	EPDM	KENET SIZDIRMAZLIK CONTASI interlock gasket	200mt/pk 0,050kg/mt

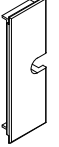

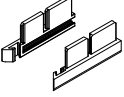

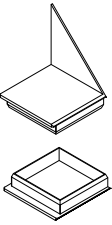
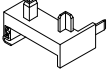

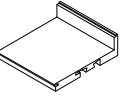
UNIQUEslideMS
KALDIR ve SÜR KAPI SİSTEMİ
LIFT&SLIDE DOOR SYSTEM



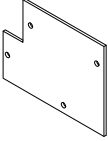
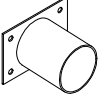
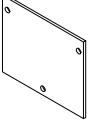

AKSESUARLAR
ACCESSORIES

AKSESUAR ŞEKLİ ACCESSORIES SHAPE	AKSESUAR ACCESS. NO	AKSESUAR TANIMI ACCESSORIES DESCRIPTION	MİKTAR QUANTITY
	700 356	KANAT İÇ BİNİ İÇİN ONBAŞI aluminum corner angle for sash	500 adet/pieces
	700 303	PVC KÖŞE ONBAŞI pvc corner angle for architrave	500 adet/pieces
	700 479	STEEL KÖŞE ONBAŞI steel corner angle for architrave	100 adet/pieces
	700 329	STEEL KÖŞE ONBAŞI steel corner angle for architrave	100 adet/pieces
	322 112	KANAT DURDURUCU BUMPER for SASH	50 adet/pieces
	700 473	KANAT DURDURUCU bumper for sash	50 adet/pieces
	700 735	KASA ALT SIZDIRMAZLIK SÜNGERİ bottom tightness plug for frame	20 adet/pieces
	700 738	KASA ÜST SIZDIRMAZLIK PARÇASI top tightness plug for frame	20 adet/pieces
	702 360	35 mm KENET İÇİN KASA ALT SIZDIRMAZLIK SÜNGERİ bottom tightness plug of the frame for 35mm interlock	20 adet/pieces
	702 361	35 mm KENET İÇİN KASA ÜST SIZDIRMAZLIK PARÇASI top tightness plug of the frame for 35mm interlock	20 adet/pieces

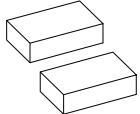
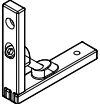
AKSESUAR ŞEKLİ ACCESSORIES SHAPE	AKSESUAR ACCESS. NO	AKSESUAR TANIMI ACCESSORIES DESCRIPTION	MİKTAR QUANTITY
	700 612	ALT KASA için YALITIM BANTI adhesive tape for bottom frame	50 adet/pieces
	700 613	ÜST KASA için YALITIM BANTI adhesive tape for top frame	50 adet/pieces
	702 354	SIFIR EŞİK KASA PROFİLİ için YALITIM BANTI adhesive tape for flat sill bottom frame profile	50 adet/pieces
	700 742	ÜST KENET KAPAK SETİ interlock top cover plug	10 adet/pieces
	700 743	ALT KENET KAPAK SETİ interlock bottom cover plug	10 çift/pair
	700 451	SU TAHLİYE KAPAGI Water drain cap (tüm kasa profilleri ile kullanılır)	50 adet/pieces
	700 672	VALFLİ SU TAHLİYE KAPAGI water drain cap with walve	50 adet/pieces
	702 231	KANAT SALLANTI ENGELLEME TAKOZU anti swing block for sash	100 adet/pieces
	700 741	KANAT STOPERİ sash bumper plug	10 adet/pieces
	700 527	KİLİT KARŞILIK KAPAĞI locking device cover	20 adet/pieces

AKSESUAR ŞEKLİ ACCESSORIES SHAPE	AKSESUAR ACCESS. NO	AKSESUAR TANIMI ACCESSORIES DESCRIPTION	MİKTAR QUANTITY
	700 758	PVC KAPAK pvc cap plug	50 çift/pair
	700 864	TAKVİYELİ KANAT PROFİLİ ALT ve ÜST KAPAGI pvc cap plug for reinforcement sash	10 çift/pair
	700 799	TAKVİYELİ KANAT PROFİLİ ALT ve ÜST KAPAGI pvc cap plug for reinforcement sash	10 çift/pair
	702 359	KENET İLAVE SIZDIRMAZLIK PARÇASI SAĞ Additional tightness plug for interlock right	20 adet/pieces
	702 357	KENET İLAVE SIZDIRMAZLIK PARÇASI SOL Additional tightness plug for interlock left	20 adet/pieces
	702 358	KENET İLAVE SIZDIRMAZLIK PARÇASI Additional tightness plug for interlock	20 adet/pieces
	700 614	ORTA KAYIT T BİRLEŞİM EPDM KÖPÜK epdm foam for T joint for mullion	50 adet/pieces
	702 353	ORTA KAYIT T BİRLEŞİM EPDM KÖPÜK epdm foam for T joint for mullion	50 adet/pieces
	702 369	101 mm KENET İÇİN SIFIR EŞİK KASA ALT SIZDIRMAZLIK SÜNGERİ bottom tightness plug of the Flat Sill Bottom Frame for 101mm interlock	50 adet/pieces

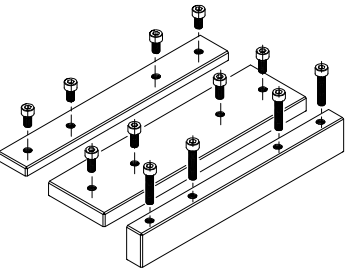
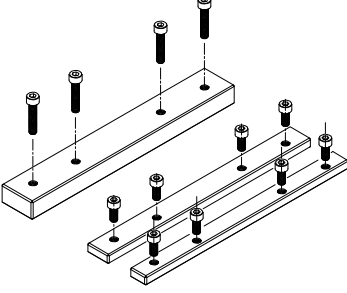

AKSESUAR ŞEKLİ ACCESSORIES SHAPE	AKSESUAR ACCESS. NO	AKSESUAR TANIMI ACCESSORIES DESCRIPTION	MİKTAR QUANTITY
	702 355	35 mm KENET İÇİN SIFIR EŞİK KASA ALT SIZDIRMAZLIK SÜNGERİ bottom tightness plug of the Flat Sill Bottom Frame for 35mm interlock	50 adet/pieces
	702 300	KİLİT KARŞILIGI locking device	20 adet/pieces
	700 988	SU KANALI PROFİLİ UC KAPAKLARI P 2328 için(For P 2328) end dam for water channel profile	20 adet/pieces
	700 989	SU BORUSU BAĞLANTISI water pipe connection	20 adet/pieces
	701 052	SU KANALI PROFİLİ UC KAPAKLARI P 2467 için(For P 2467) end dam for water channel profile	20 adet/pieces
	702 343	300 KG LİK ARABA DESTEK TAKOZU adhesive tape for bottom frame	10 çift/pair
	702 341	KENET İLAVE SIZDIRMAZLIK PARÇASI Additional tightness plug for interlock	20 adet/pieces
	702 338	KENET İLAVE SIZDIRMAZLIK PARÇASI Additional tightness plug for interlock	20 adet/pieces
	702 363	CAM MESAFE AAYARLAMA TAKOZ DISTANCE ADJUSTMENT PIECE	50 çift/pair
	700 684	CIVATALI PVC KÖŞE TAKOZU bolted pvc corner wedge	100 adet/pieces

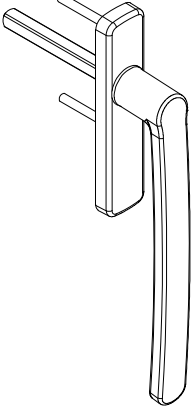
AKSESUAR ŞEKLİ ACCESSORIES SHAPE	AKSESUAR ACCESS. NO	AKSESUAR TANIMI ACCESSORIES DESCRIPTION	MİKTAR QUANTITY
	702 344	YSB İNOX VİDA stainless steel pan head screw	200 adet/pieces
	702 345	YHB İNOX VİDA stainless steel countersunk screw	200 adet/pieces
	702 356	YSB İNOX VİDA stainless steel pan head screw	200 adet/pieces
	702 352	YSB İNOX VİDA stainless steel pan head screw	200 adet/pieces
	700 838	HAVUZLU KOL (KALDIR-SÜR SÜRME İÇİN) pool handle (for lift-slide sliding)	10 adet/pieces
	700 854	ÜST YATAY KASA PROFİL EK YERİ LAMASI top horizontal frame profile joint plate	10 tk/set
	700 855	ALT YATAY KASA PROFİL EK YERİ LAMASI bottom horizontal frame profile joint plate	10 tk/set

AKSESUAR ŐEKLİ ACCESSORIES SHAPE	AKSESUAR ACCESS. NO	AKSESUAR TANIMI ACCESSORIES DESCRIPTION	MİKTAR QUANTITY
	700 834	250mm DÜZ KOL 250mm handle	1 adet/pieces
	700 837	250mm DÜZ KOL 250mm handle	1 adet/pieces

UNIQUEslideMS
KALDIR ve SÜR KAPI SİSTEMİ
LIFT&SLIDE DOOR SYSTEM

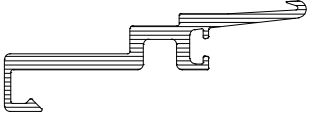
PLASTİK PROFİLLER
PVC PROFILES

PROFİL ŞEKLİ PROFILE SECTION	PROFİL KODU PROFILE NO	MALZEME MATERIAL	PROFİL TANIMI PROFILE DESCRIPTION	PAKET PACKAGE
 0,170kg/mt	600 419	PVC	DAR PVC KENET PROFİLİ pvc interlock for slim sash	6mt 25ad/pk
 0,310kg/mt	600 459	POLYAMİD	GENİŞ KENET PROFİLİ interlock for wide sash	6mt 25ad/pk
 0,110kg/mt	600 448	PVC	KASA KANAL KAPATMA PROFİLİ frame closing profile	6mt 25ad/pk
 0,305kg/mt	600 520	POLYAMİD	DAR KENET PROFİLİ interlock for slim sash	6mt 25ad/pk

UNIQUEslideMS
KALDIR ve SÜR KAPI SİSTEMİ
LIFT&SLIDE DOOR SYSTEM

UYGULANABİLİR AÇILIM TİPLERİ
APPLICABLE OPENING TIPOLOGIES

tek raylı kasa,tek kanat kayar,tek sabit camlı
single track,single sash slide,single fix glass

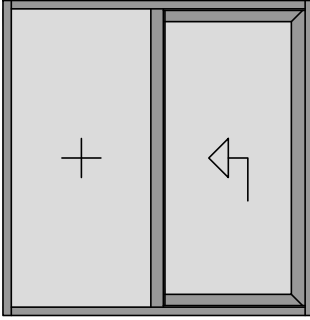

dış görünüş-external view

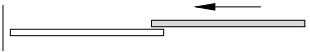

tek raylı kasa,tek kanat kayar,iki sabit camlı
single track,single sash slide,double fix glass

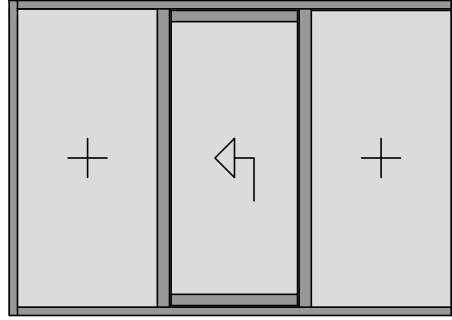

dış görünüş-external view

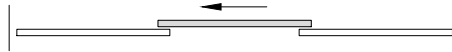

tek raylı kasa,çift kanat kayar,çift sabit camlı
single track,two sashes slide,two fix glasses

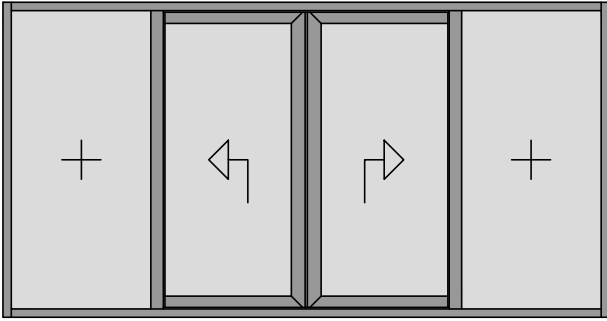

dış görünüş-external view



tek raylı kasa,çift kanat kayar,ortada tek sabit camlı
single track,two sashes slide,single fix glass in the middle

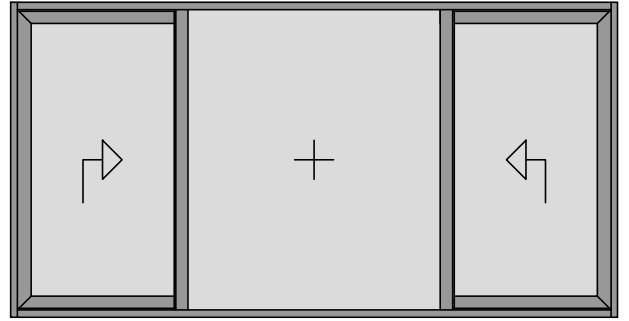

dış görünüş-external view



tek raylı kasa,tek kanat kayar,tek sabit camlı üst sabit
single track,single sash slide,single fix glass top fix

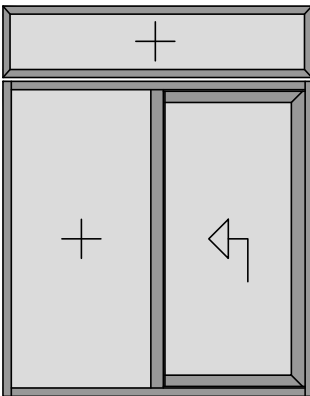

dış görünüş-external view

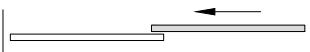

tek raylı kasa,tek kanat kayar,üç sabit camlı
single track,single sash slide,trible fix glass

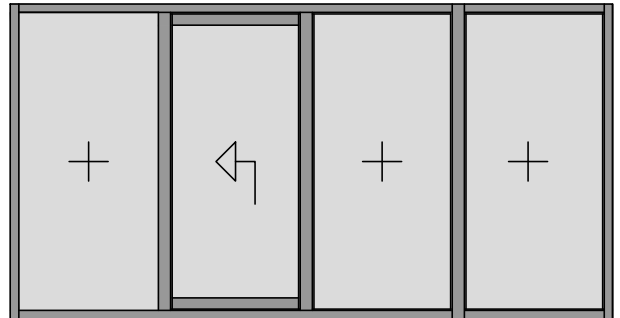

dış görünüş-external view



UNIQUEslideMS
KALDIR ve SÜR KAPI SİSTEMİ
LIFT&SLIDE DOOR SYSTEM

TAM ÖLÇEKLİ ALUMİNYUM PROFİLLER
FULL SCALE ALUMINIUM PROFILES

P 2101

Yan Kasa Profili / 2,265kg/mt
Side Frame Profile

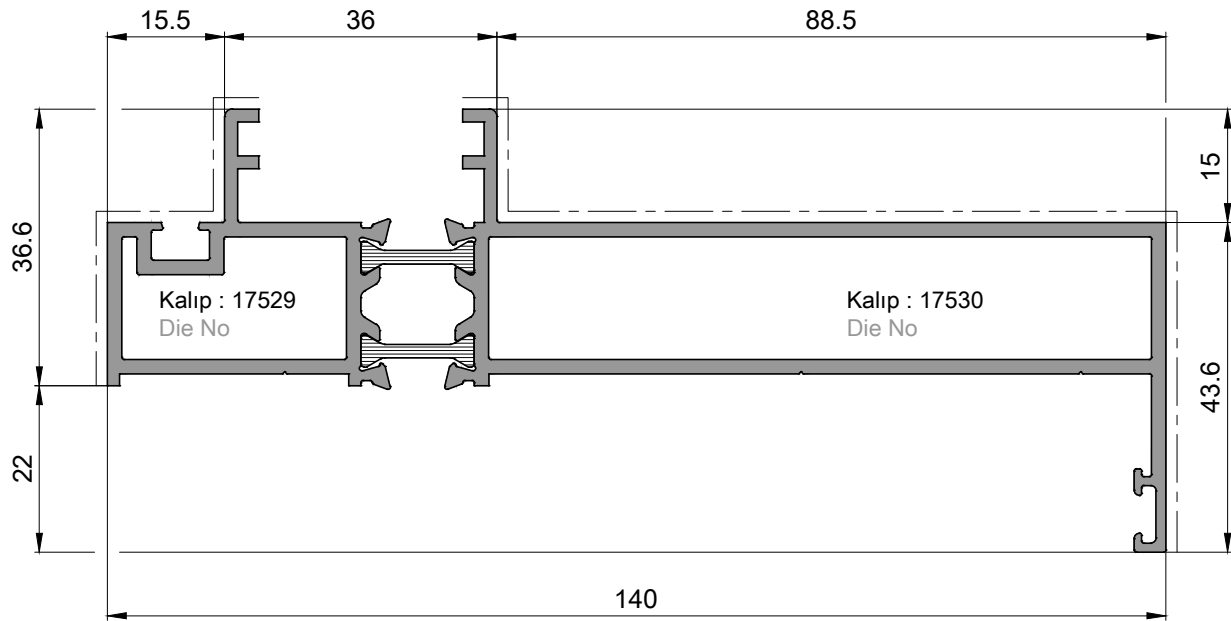

P 2102

Yan Kasa Profili / 2,250kg/mt
Side Frame Profile

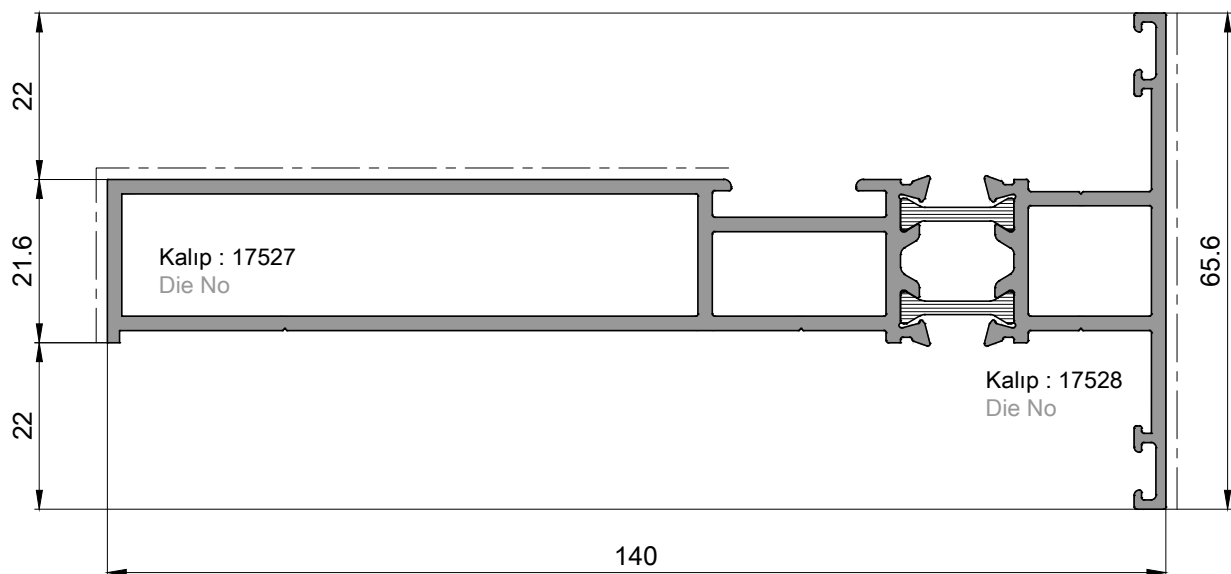

P 2397

Yan Kasa Profili / 2,140kg/mt
Side Frame Profile

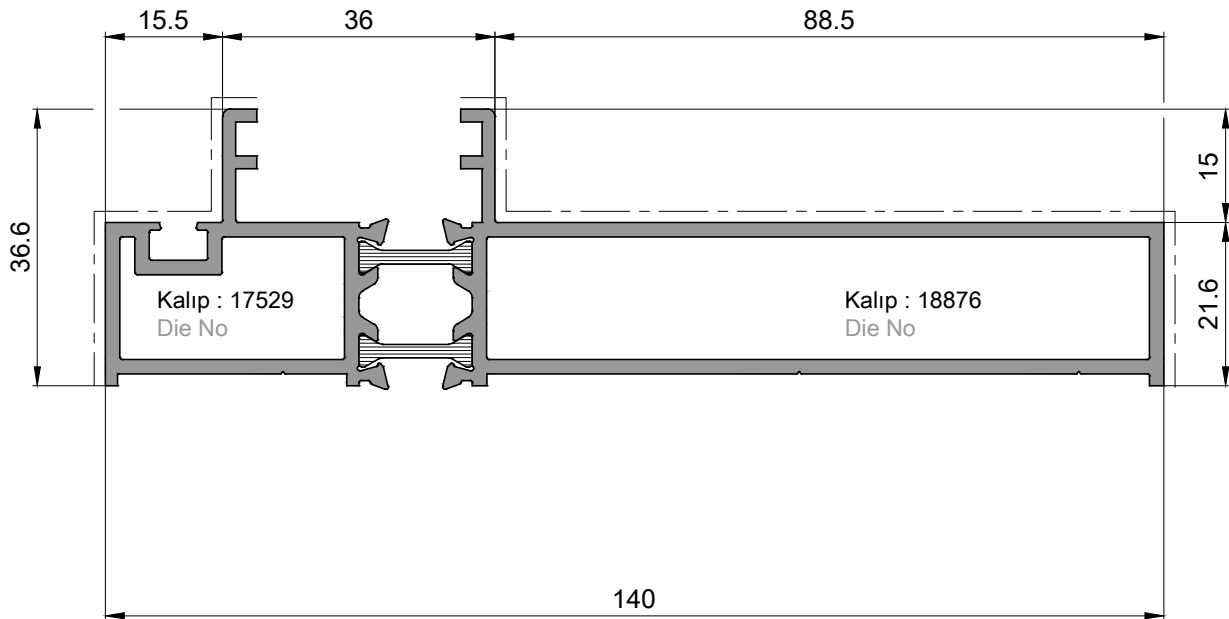

P 2398

Yan Kasa Profili / 2,125kg/mt
Side Frame Profile

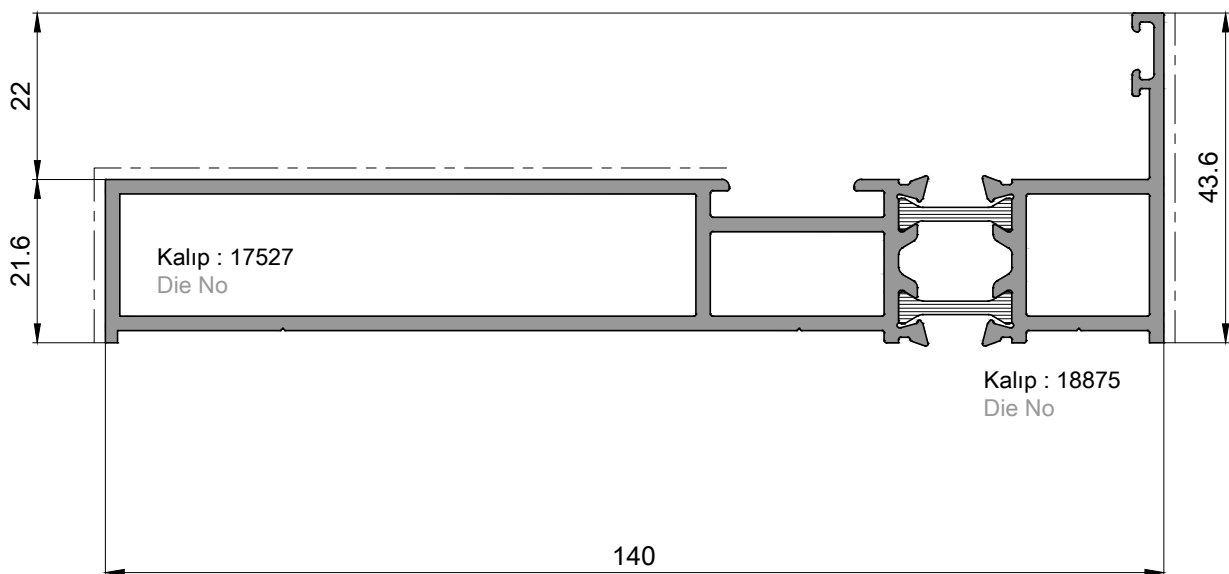

P 2103

Alt Kasa Profili / 3.155kg/mt
Bottom Frame Profile

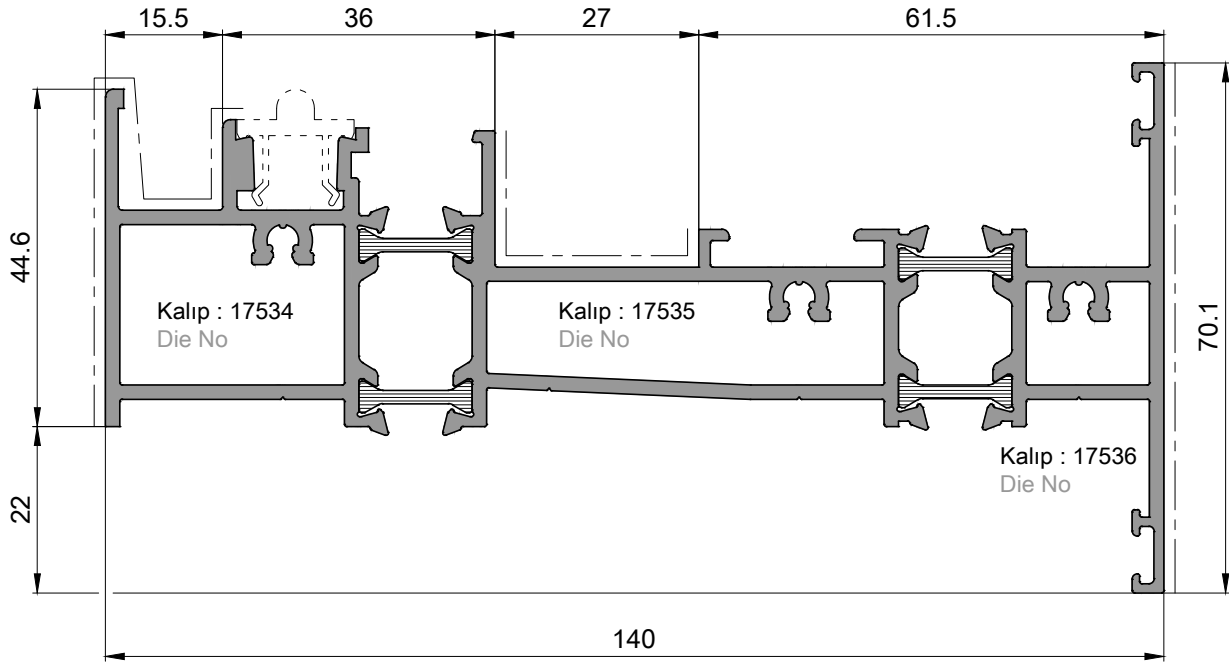

P 2104

Üst Kasa Profili / 3.645kg/mt
Top Frame Profile

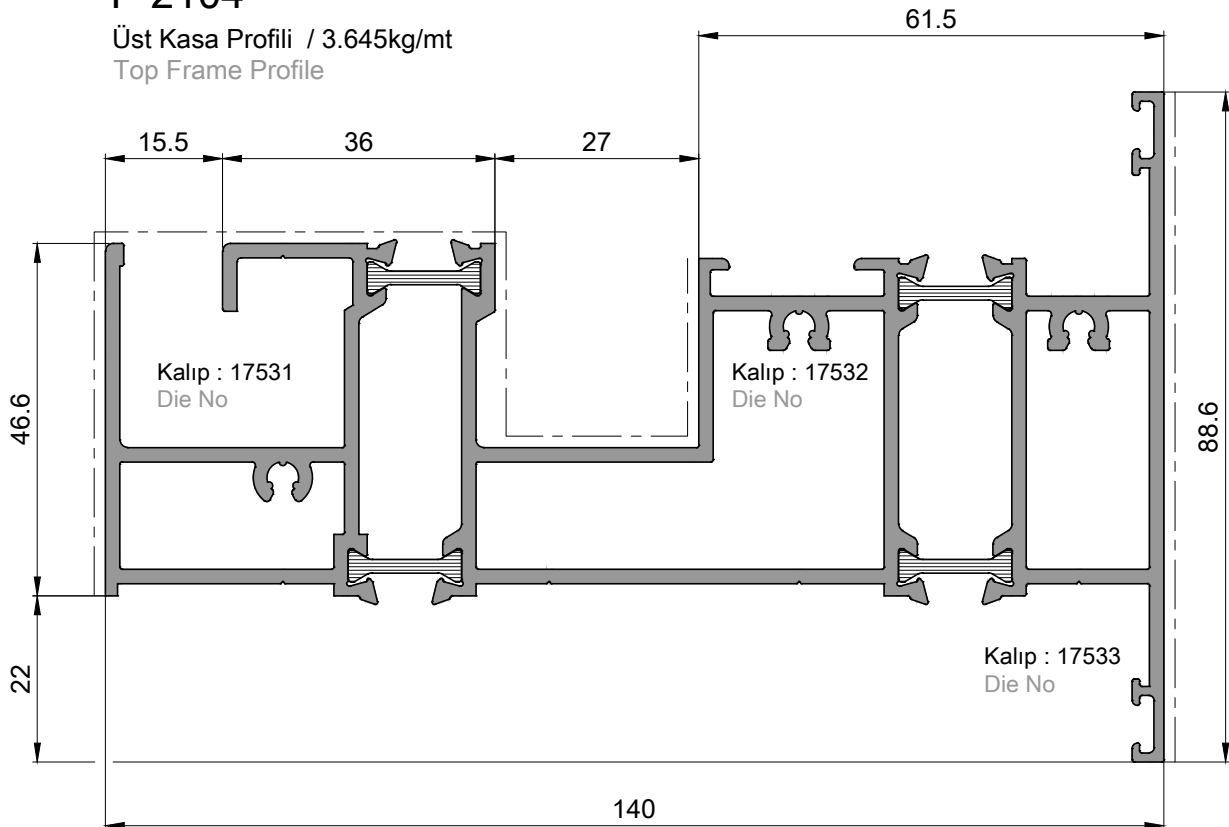

P 2399

Alt Kasa Profili / 3.035kg/mt
Bottom Frame Profile

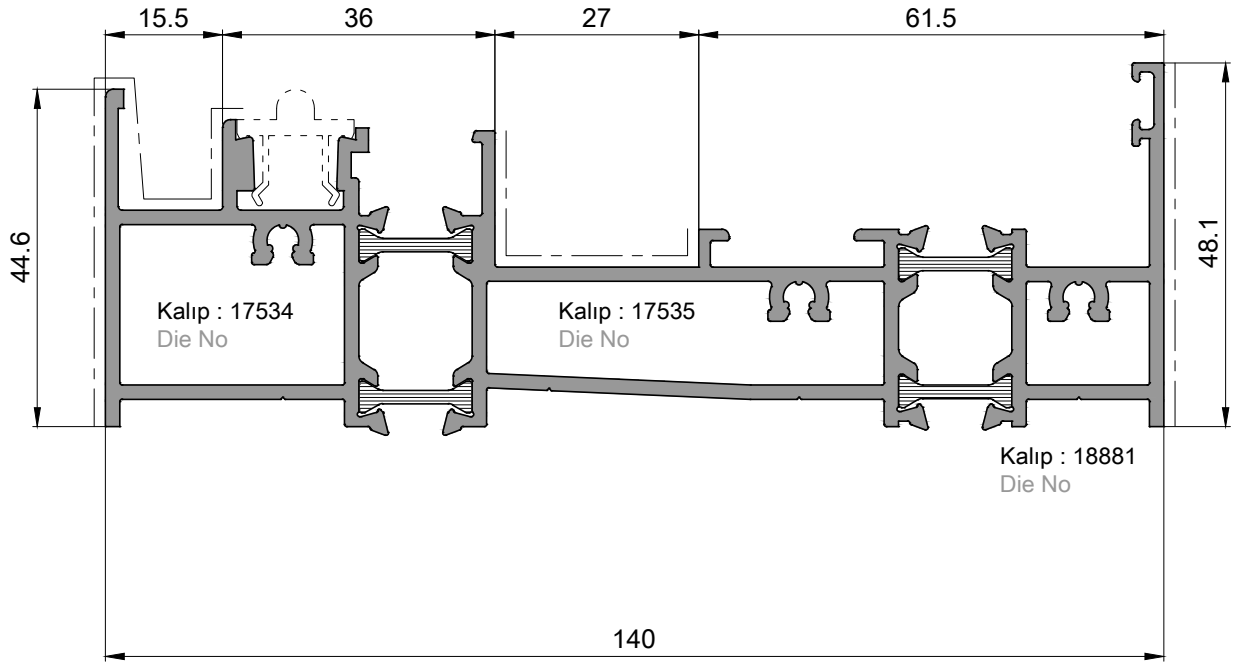

P 2401

Üst Kasa Profili / 3.830kg/mt
Top Frame Profile

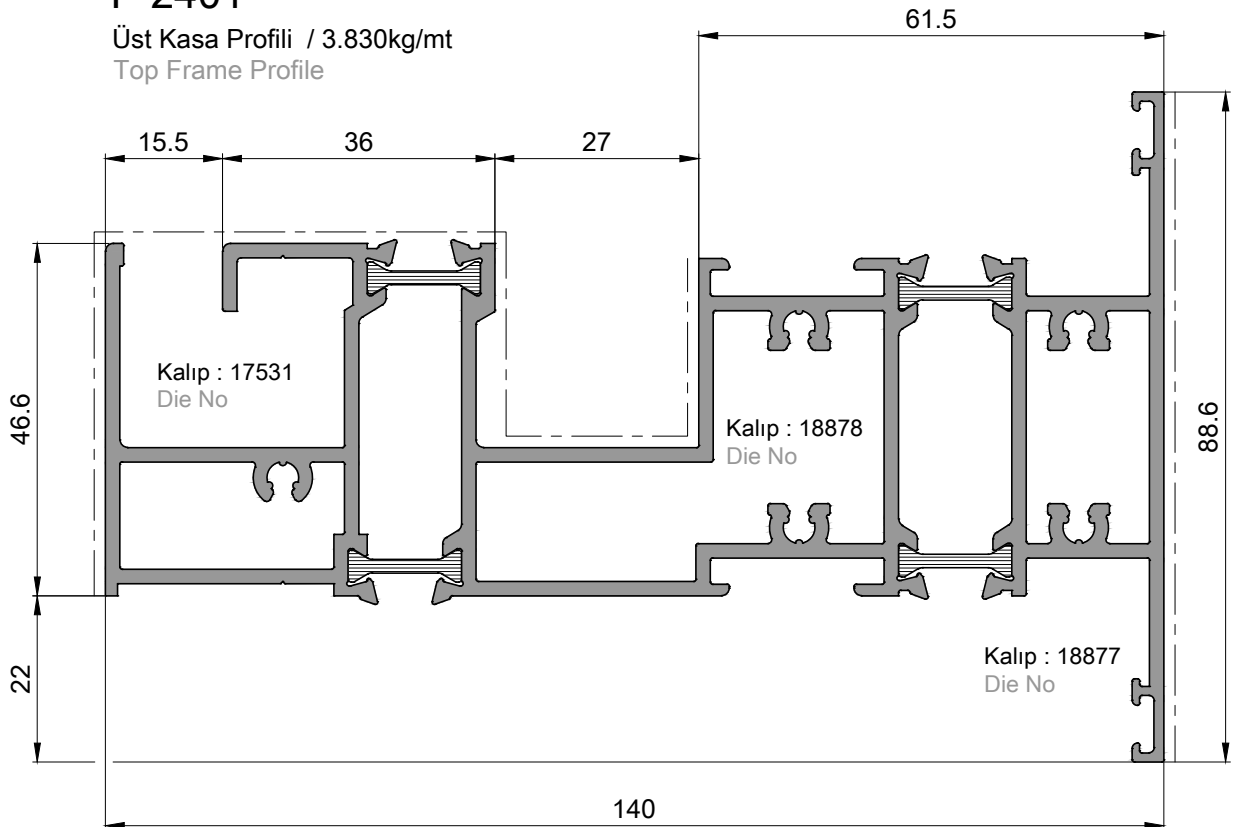

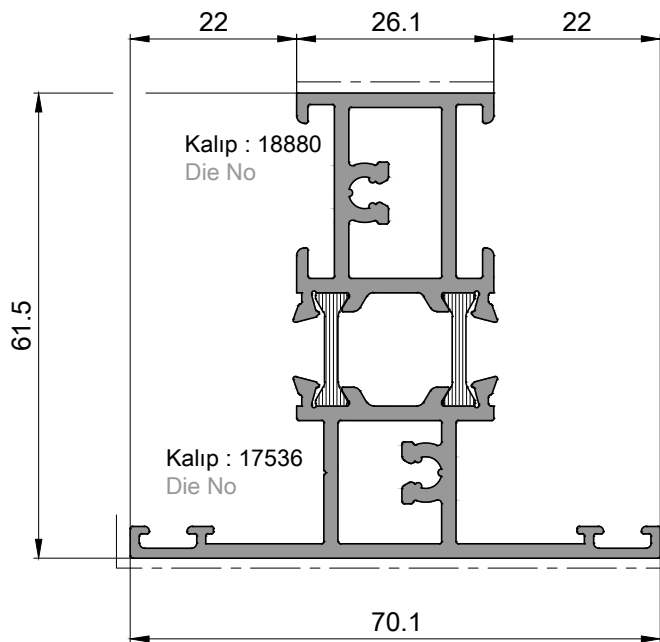
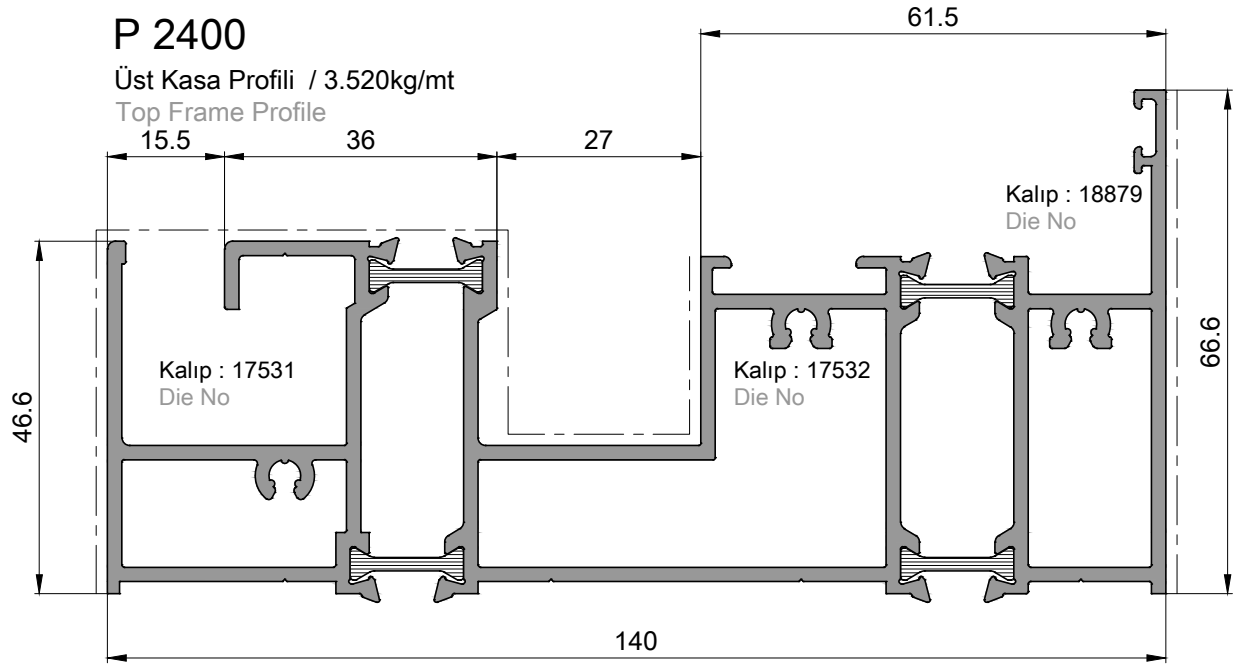

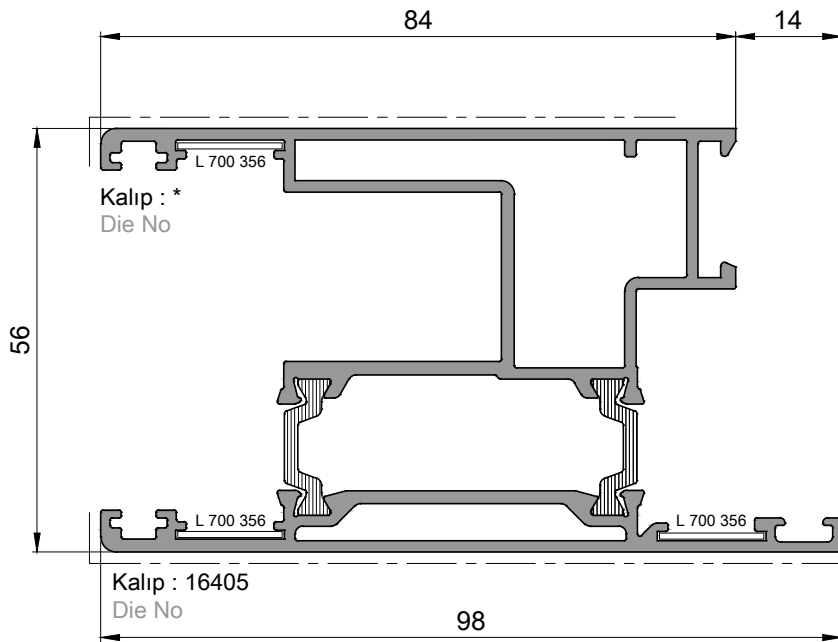

P 2402
Ortakayıt Profili / 1,605kg/mt
Mullion Profile

I_x 18.18 cm⁴ I_y 8.69 cm⁴



P 3096

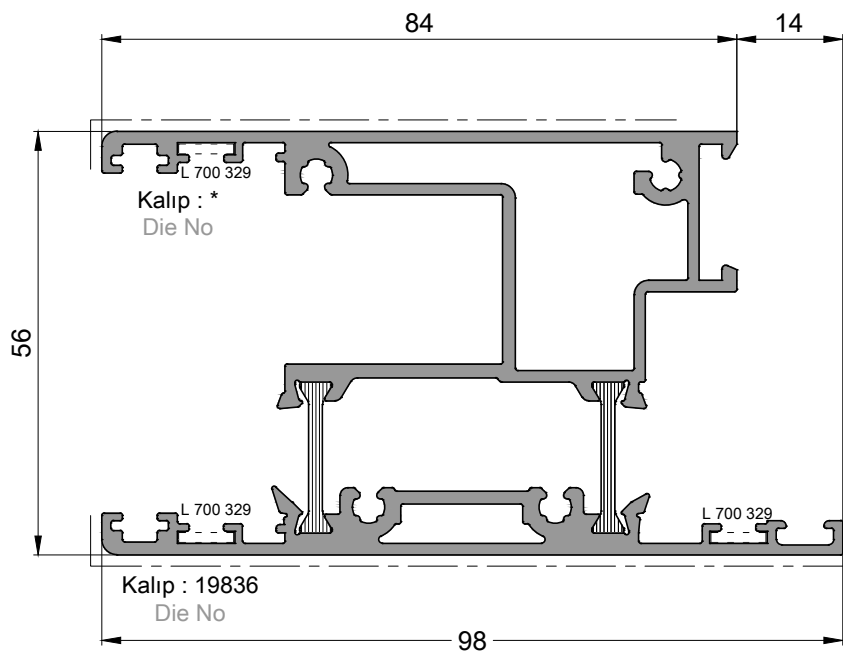

Kanat Profili / 2.075 kg/mt
Sash Profile

I_x  24.62 cm⁴ I_y  42.51 cm⁴



P 3097

Kanat Profili / 2.300kg/mt
Sash Profile

I_x  28.74 cm⁴ I_y  46.06 cm⁴

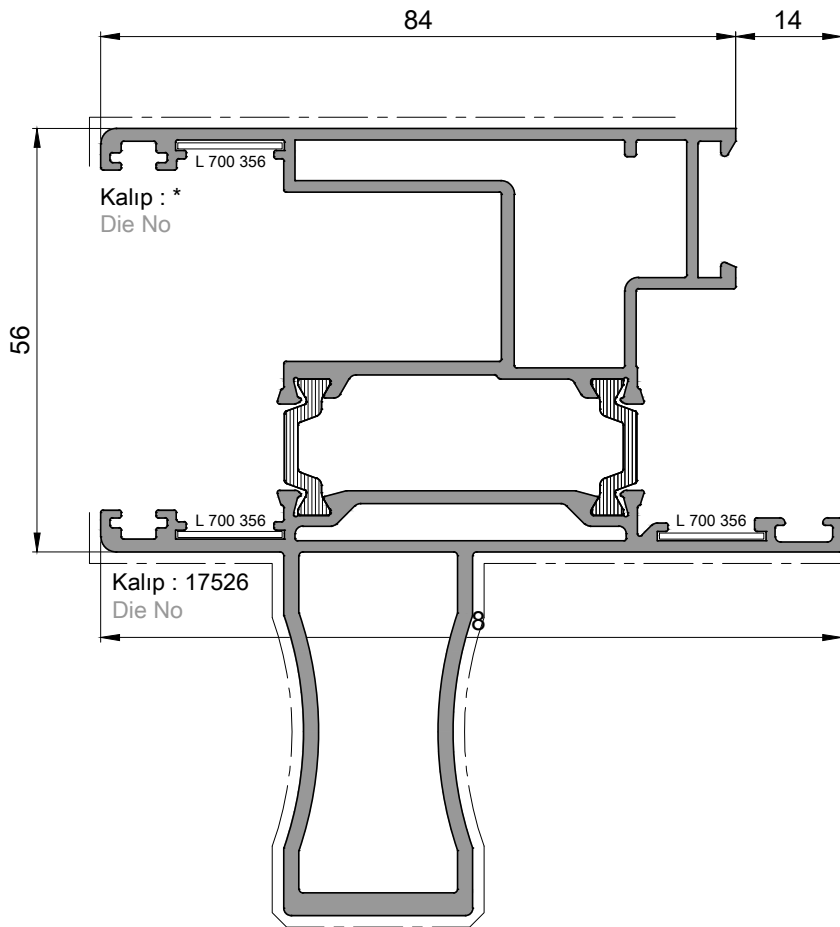

P 3100

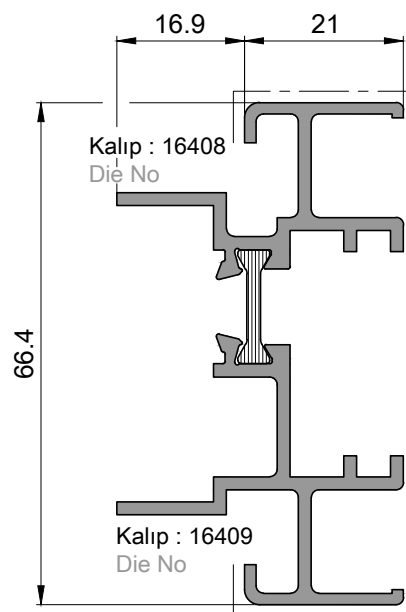

Kanat Profili / 2,775kg/mt
Sash Profile

I_x  74.24 cm⁴ I_y  44.98 cm⁴



P 1739

Adaptör Profili / 1.035kg/mt
Adepter Profile

I_x  13.98 cm⁴ I_y  2.68 cm⁴

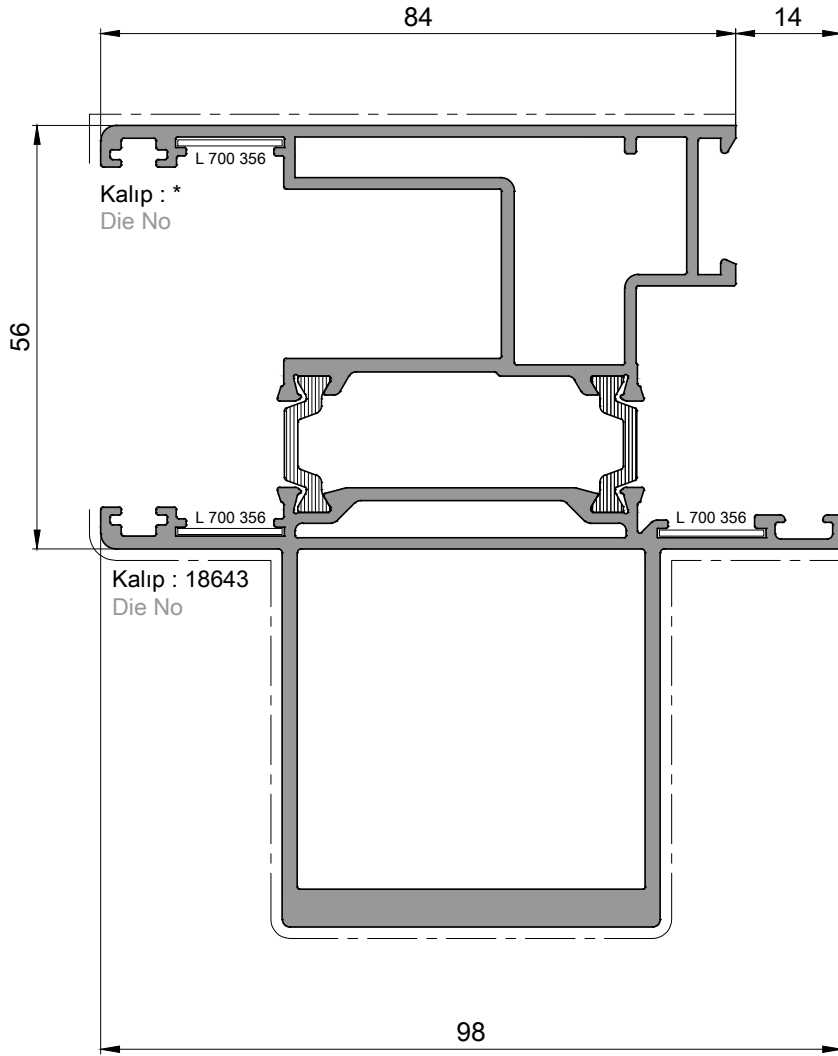

P 3098

Kanat Profili / 3,240kg/mt
Sash Profile

ix) 111.71 cm⁴ ly) 57.44 cm⁴

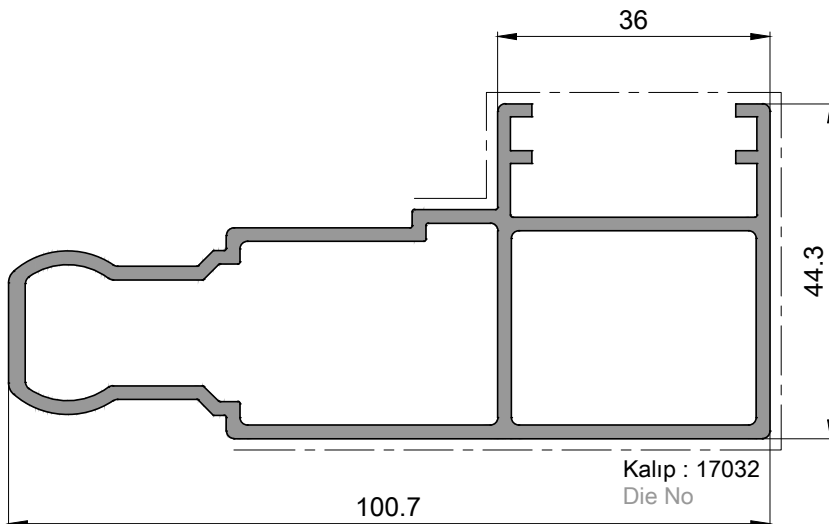

P 1752

Kilitleme Adaptör Profili / 1,565kg/mt
Locking Adapter Profile

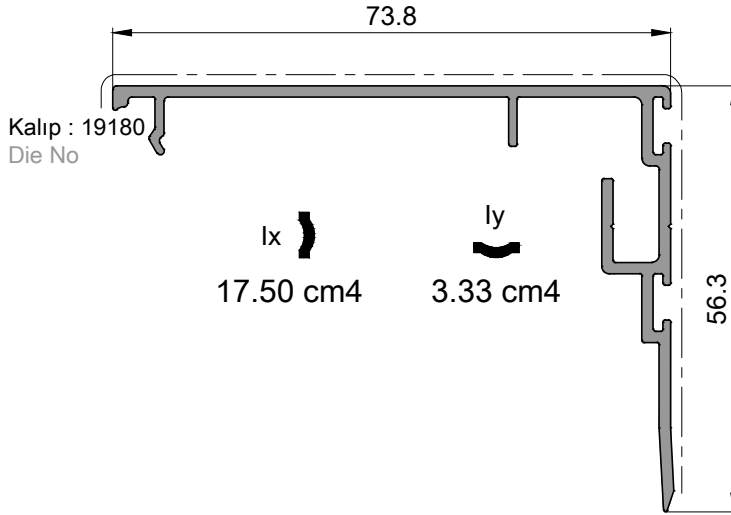

P 2111

Kapatma Profili / 0.681kg/mt
Closing Profile

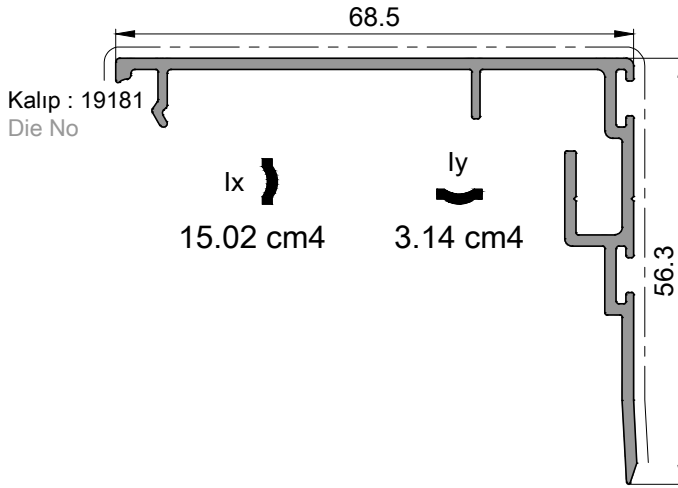

P 2110

Kapatma Profili / 0.660kg/mt
Closing Profile

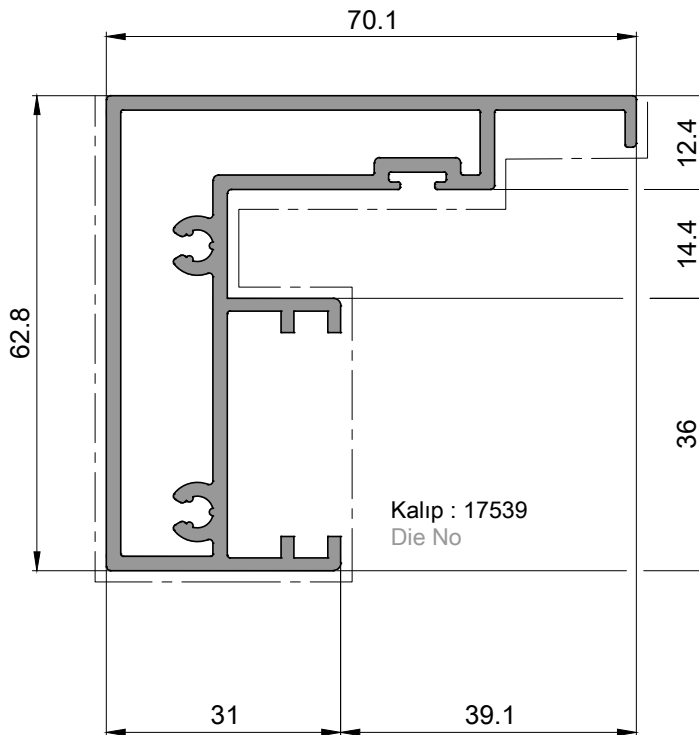

P 2107

Adaptör Profili / 1.590kg/mt
Adepter Profile

P 3099

KÖŞE KANAT PROFİLİ / 2.480kg/mt
Corner Sash Profile

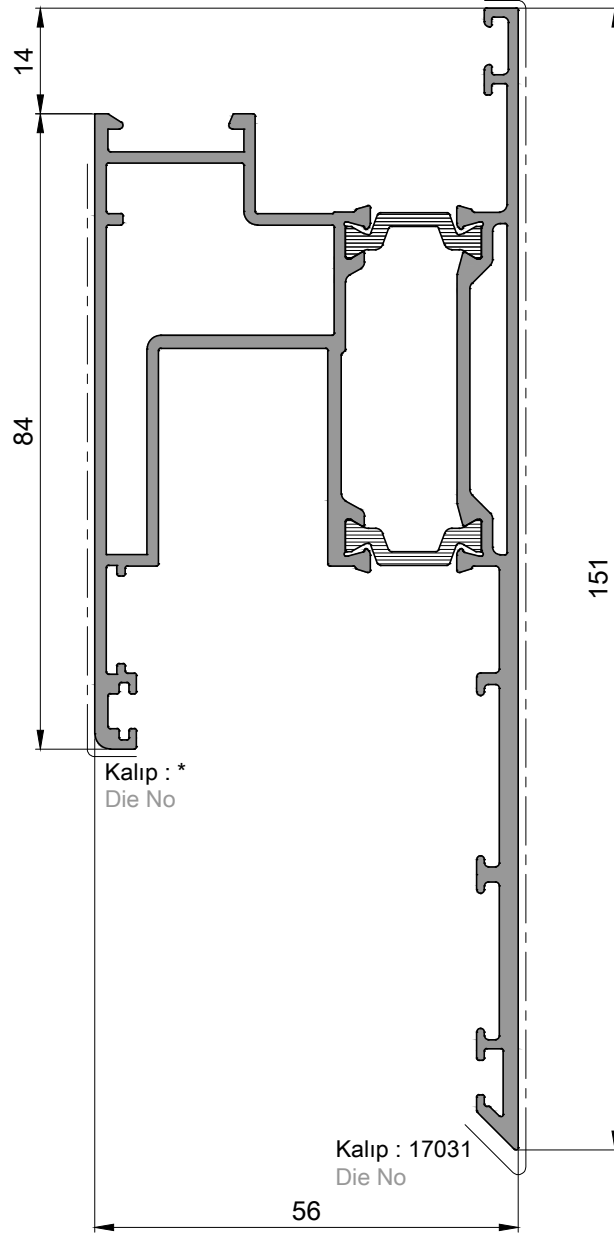

I_x) 26.31 cm⁴ I_y) 117.77 cm⁴

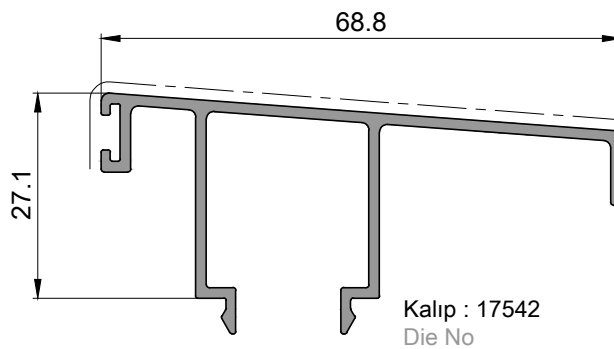

P 2108

Kapak Profili / 0.590kg/mt
Cap Profile

P 1745

Çita Profili / 0.270kg/mt
Glazing Bead Profile

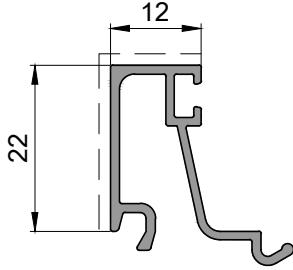

Kalıp : 16410
Die No

P 1750

Çita Profili / 0.280kg/mt
Glazing Bead Profile

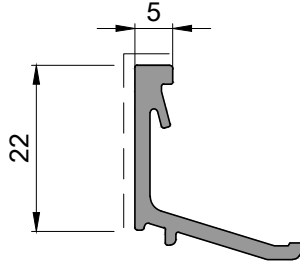

Kalıp : 12558
Die No

P 3067

Çita Profili / 0.235kg/mt
Glazing Bead Profile

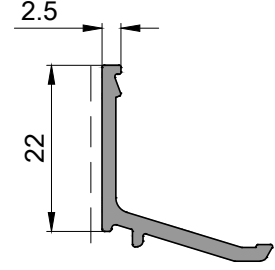

Kalıp : 9344
Die No

P 1746

Çita Profili / 0.275kg/mt
Glazing Bead Profile

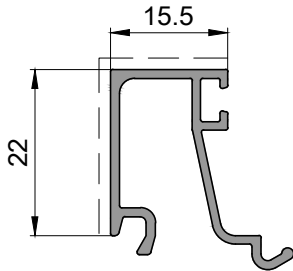

Kalıp : 16411
Die No

P 1747

Çita Profili / 0.280kg/mt
Glazing Bead Profile

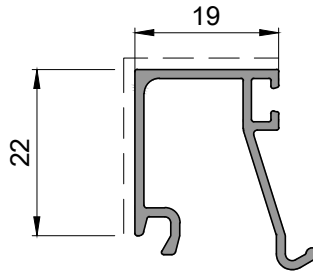

Kalıp : 16412
Die No

P 1748

Çita Profili / 0.300kg/mt
Glazing Bead Profile

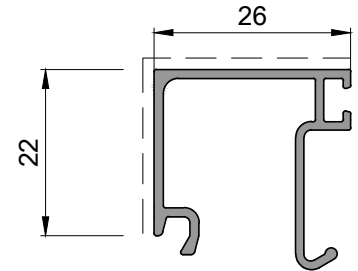

Kalıp : 16413
Die No

P 1749

Çita Profili / 0.340kg/mt
Glazing Bead Profile

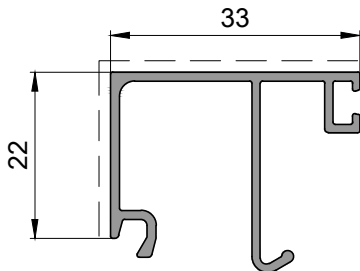

Kalıp : 16414
Die No

P 2205

Pervaz Profili / 0,340kg/mt
Architrave Profile

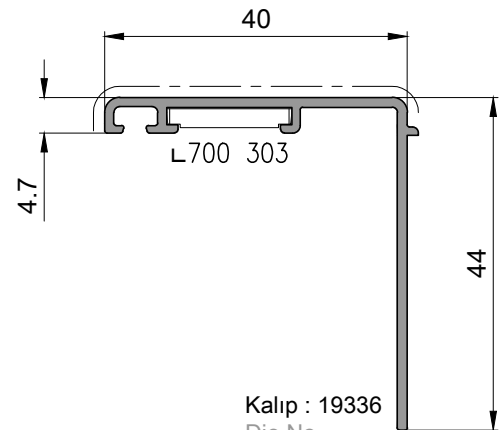

Kalıp : 19336
Die No

P 3079

Çıta Profili / 0.160kg/mt
Glazing Bead Profile

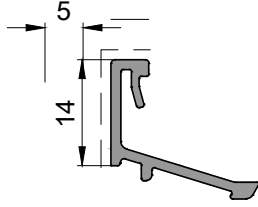

Kalıp : *
Die No

P 3080

Çıta Profili / 0.195kg/mt
Glazing Bead Profile

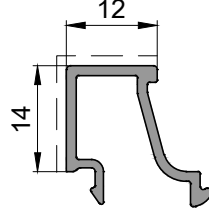

Kalıp : 9544
Die No

P 3078

Çıta Profili / 0.225kg/mt
Glazing Bead Profile

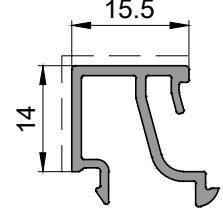

Kalıp : 20097
Die No

P 3081

Çıta Profili / 0.240kg/mt
Glazing Bead Profile

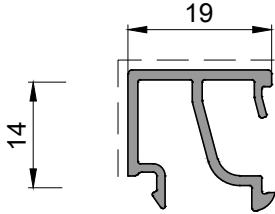

Kalıp : *
Die No

P 3082

Çıta Profili / 0.245kg/mt
Glazing Bead Profile

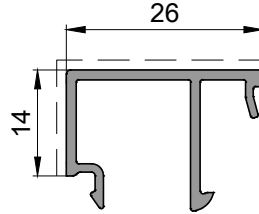

Kalıp : *
Die No

P 3083

Çıta Profili / 0.270kg/mt
Glazing Bead Profile

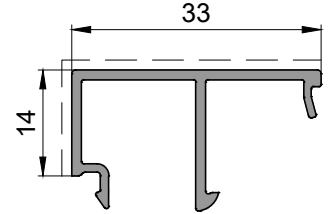

Kalıp : *
Die No

P 1740

Ray Profili / 0.180kg/mt
Rail Profile

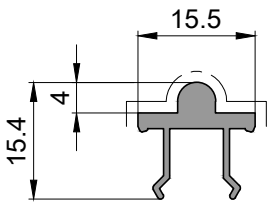

Kalıp : 16400
Die No

P 2109

Kapatma Profili / 0.155kg/mt
Closing Profile

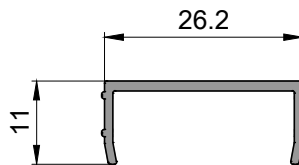

Kalıp : 17834
Die No

P 3093

Su kanalı
ek profili / 0,210kg/mt
Water channel
additional profile

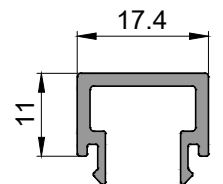

Kalıp : **
Die No

P 1222

Pervaz Profili / 0,760kg/mt
Architrave Profile

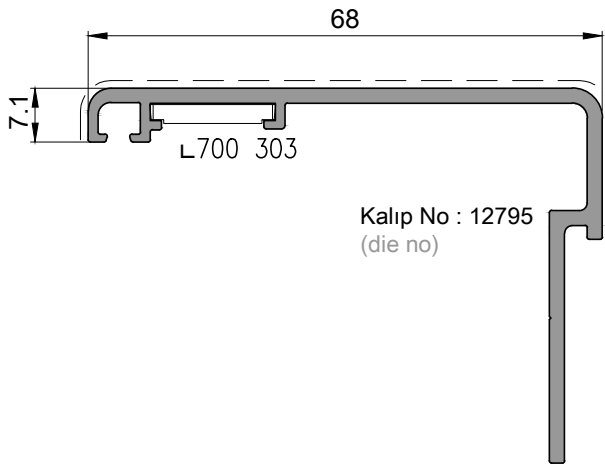

P 1321

Pervaz Profil / 0,160kg/mt
Architrave Profile

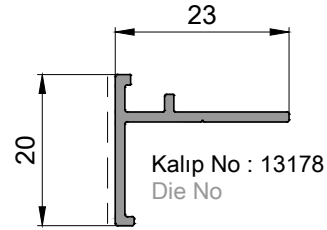

P 1761

Pervaz Profili / 0,890kg/mt
Long Architrave Profile

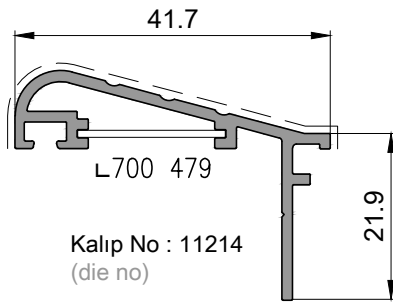
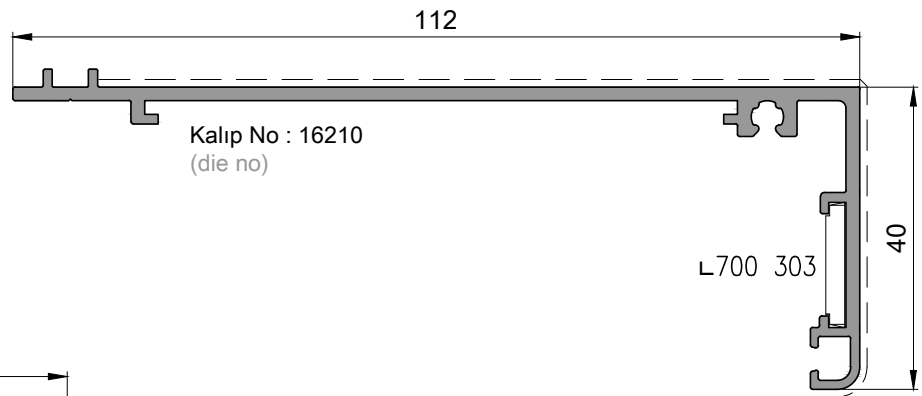

P 1287

Pervaz Profili / 0,360kg/mt
Architrave Profile

P 1177

Pervaz Profili / 0,305kg/mt
Architrave Profile

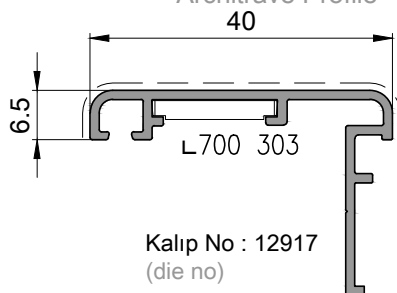

P 1178

Pervaz Profili / 0,375kg/mt
Architrave Profile

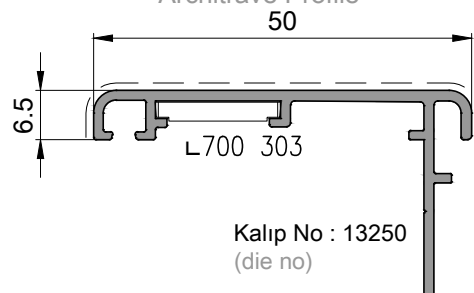

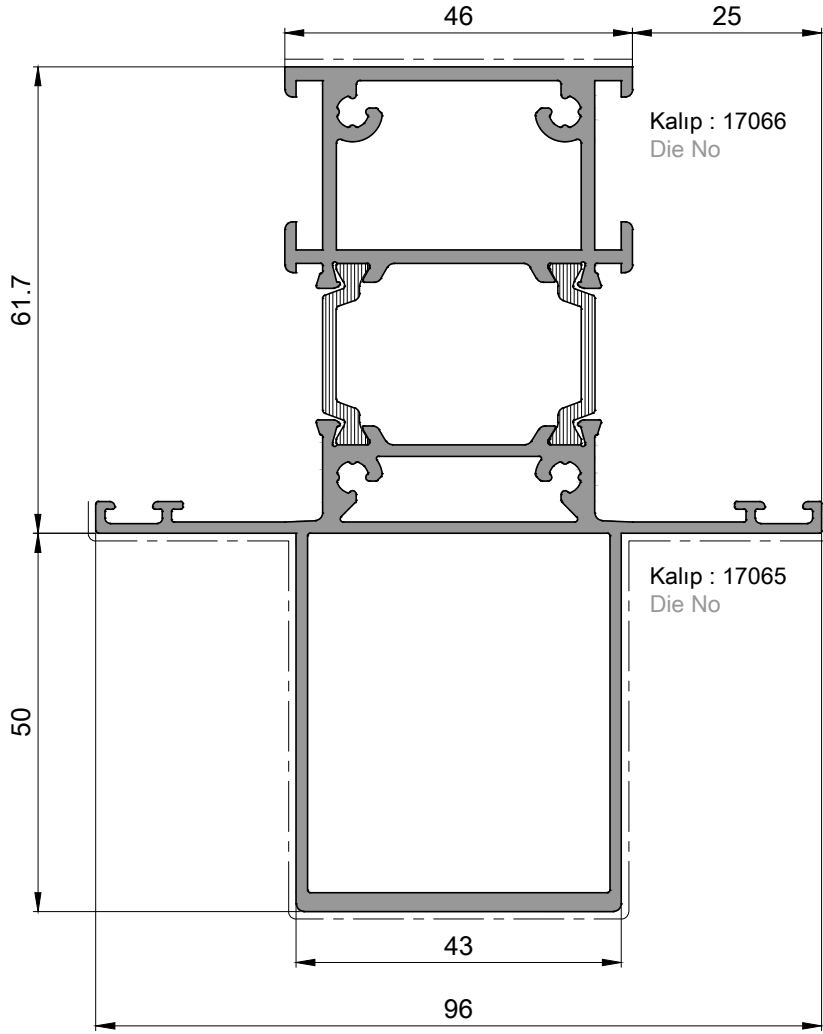

P 1753

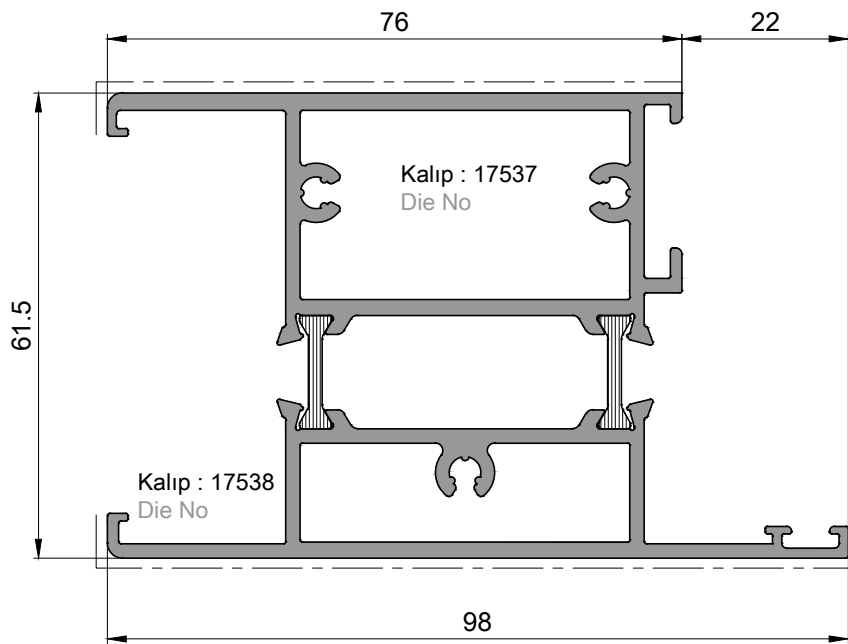

Takviyeli Orta Kayıt / 2.580kg/mt
Mullion Profile With Reinforcement

I_x  87.86 cm⁴ I_y  26.00 cm⁴



P 2105

Orta Kayıt Profili / 2.440kg/mt
Mullion Profile

I_x  34.94 cm⁴ I_y  35.44 cm⁴

P 3094

Sıfır Eşik Kasa Profili / 2.910kg/mt
Flat Sill Bottom Frame Profile

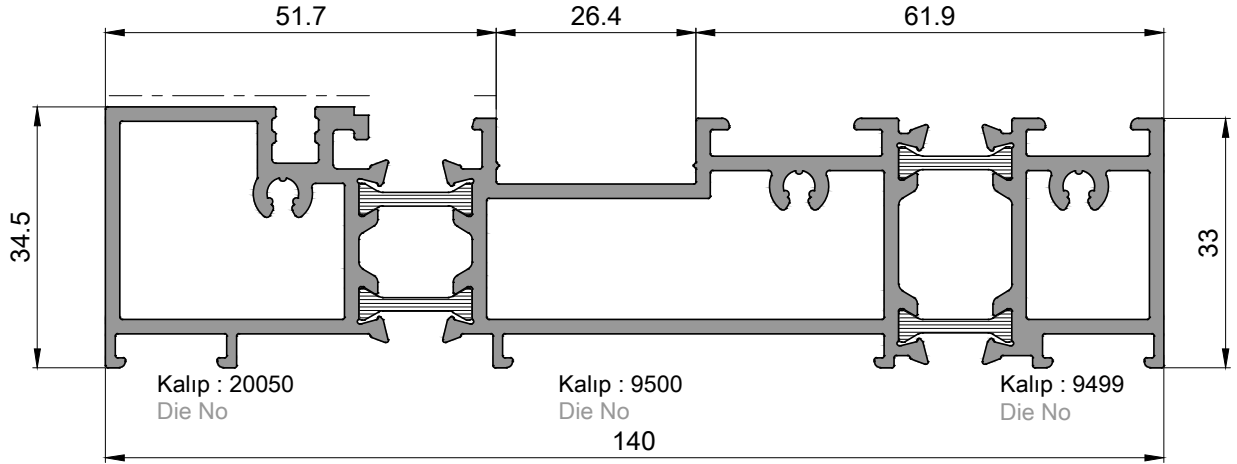

P 3095

Sıfır Eşik Kasa Profili / 3.020kg/mt
Flat Sill Bottom Frame Profile

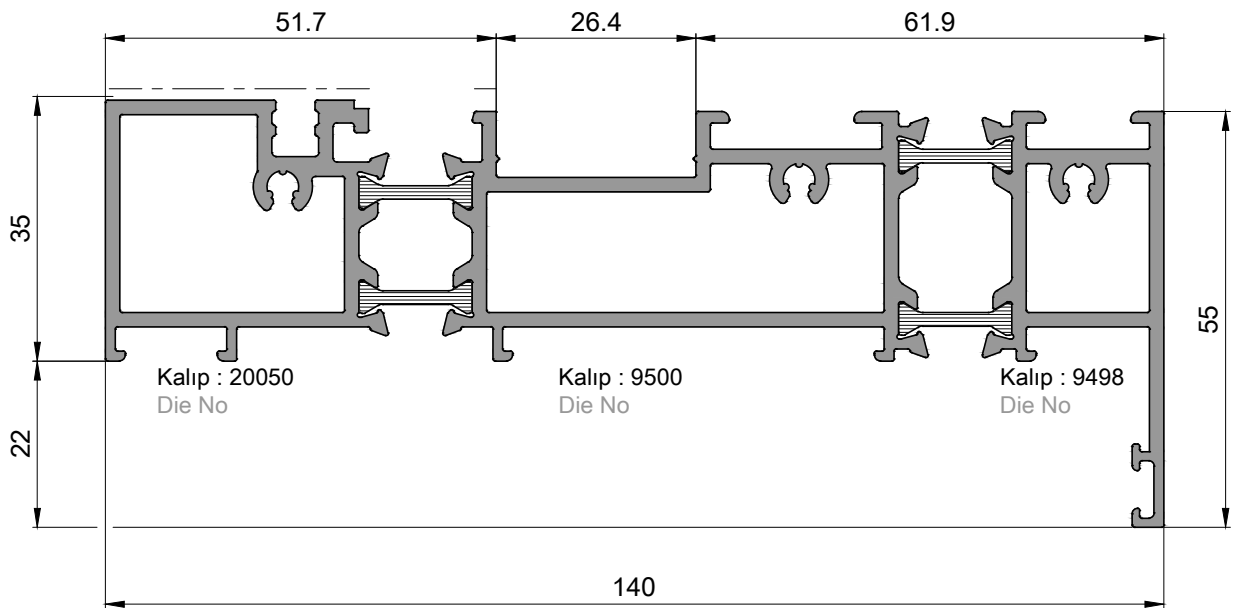

P 3103

Kapatma Profili / 0.370kg/mt
Closing Profile

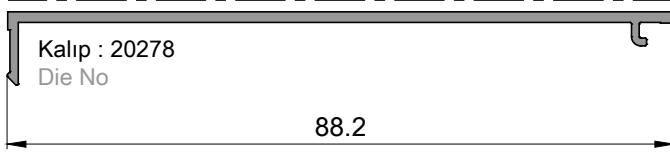

P 3087

İnce Takviyeli Kanat Profili / 2.030kg/mt
Slim Reinforcement Sash Profile

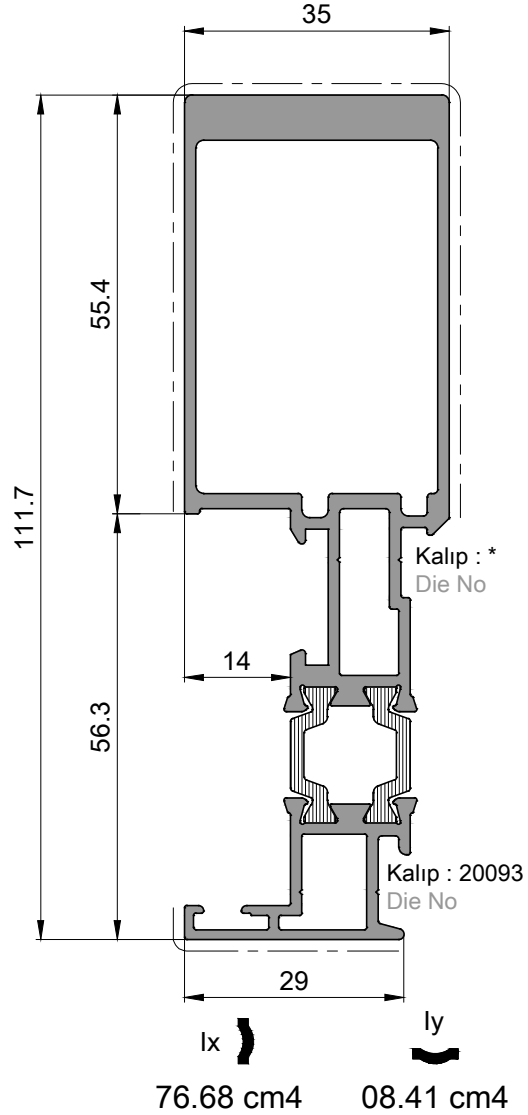

P 3085

İnce Kanat Profili / 0.940kg/mt
Slim sash profile

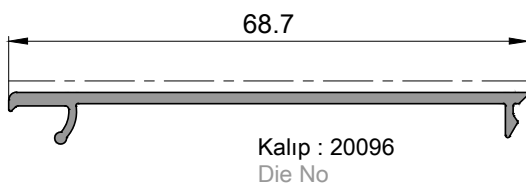
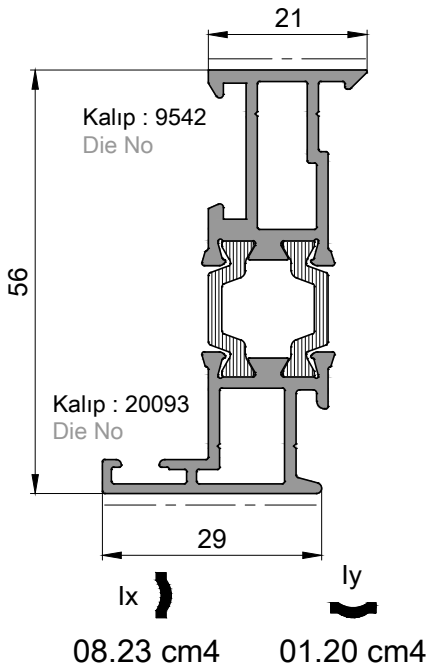

P 3077

Kapatma Profili / 0.315kg/mt
Closing Profile

P 3088

Orta Kayıt Profili / 1.100kg/mt
mullion profile

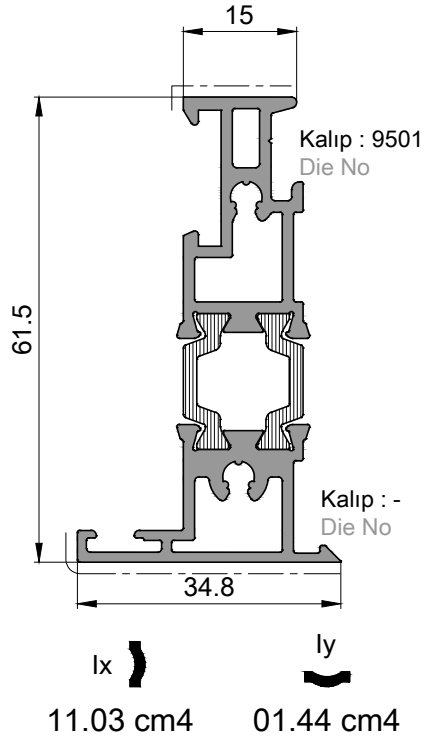

P 3076

İnce Takviyeli Kanat Profili / 2.070kg/mt
Slim Reinforcement Sash Profile

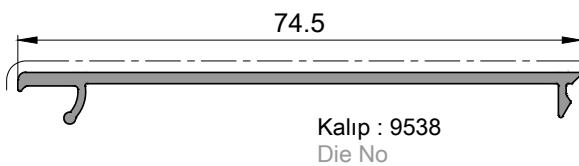
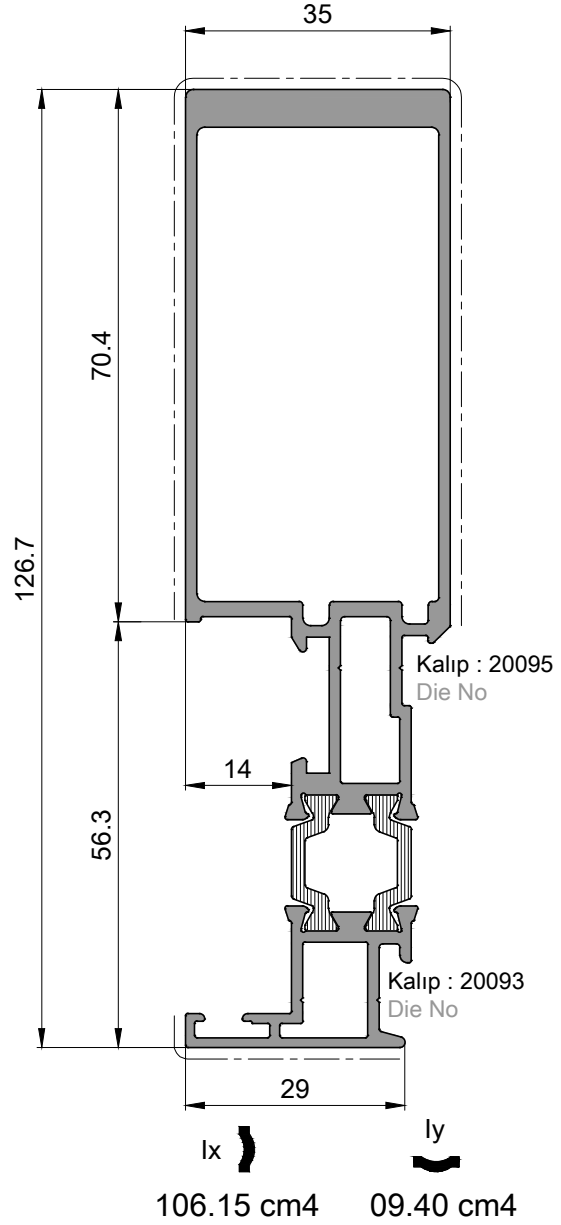

P 3086

Kapatma Profili / 0.340kg/mt
Closing Profile

P 2488

Ray Profili / 0,170kg/mt
Rail Profile

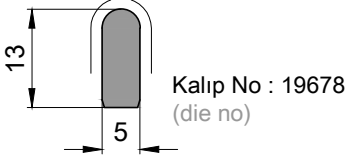

P 3091

Kapatma Profili / 0.175kg/mt
Closing Profile

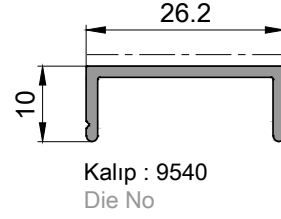

P 3084

Dıştan Takviyeli Orta Kayıt Profili / 2.060kg/mt
Exterior interlock mullion profile with reinforcement

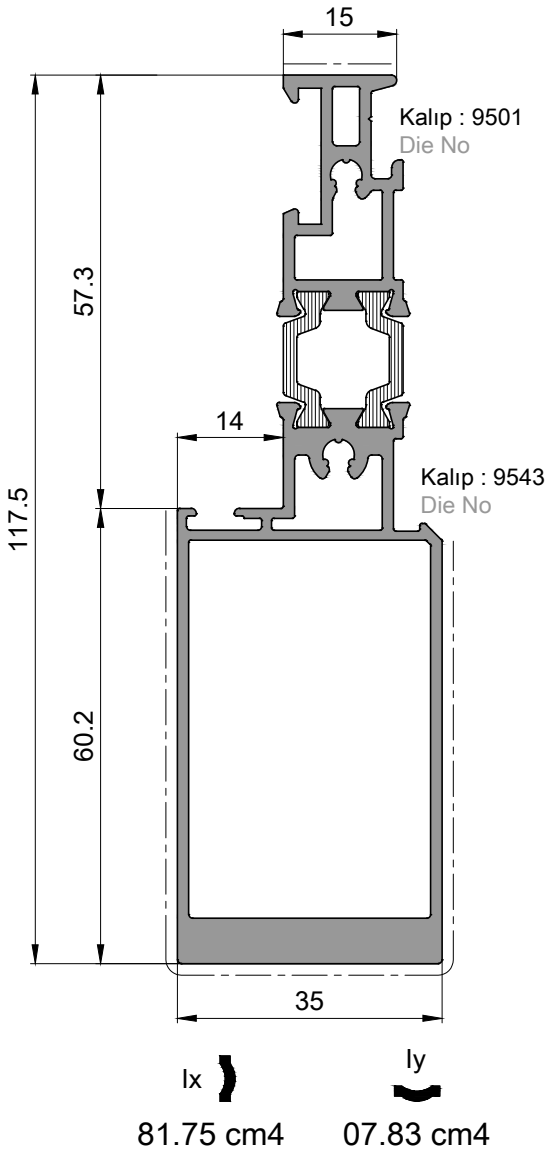

P 3092

Çıta Profili / 0.205kg/mt
Glazing Bead Profile

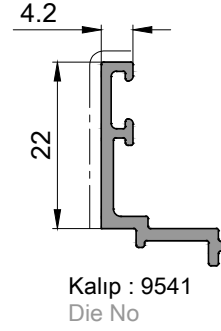

P 3072

Ray Yükseltme Profili / 0.500kg/mt
Elevation Rail Profile

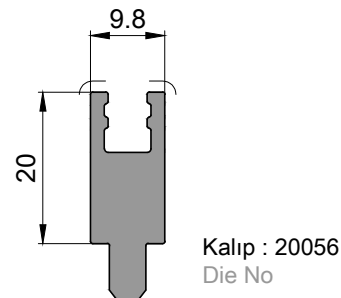

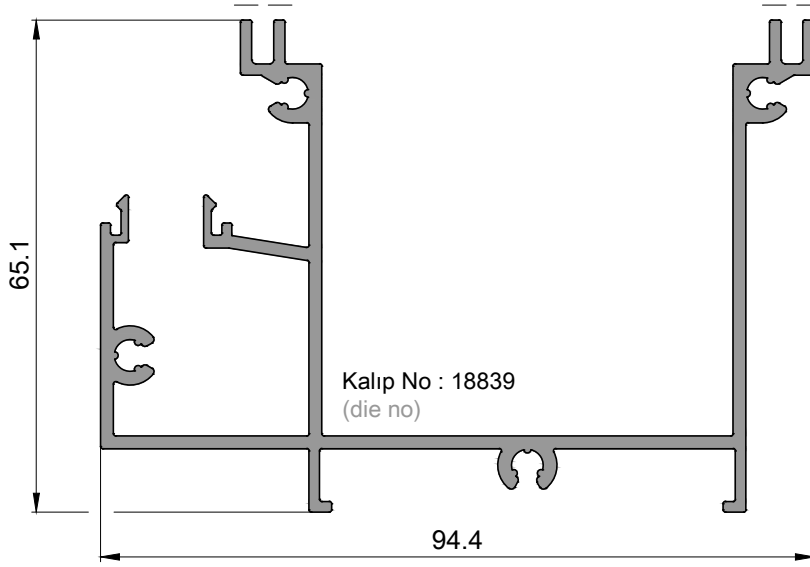

P 2328
Su Kanalı Profili
Water channel Profile
1,530kg/mt

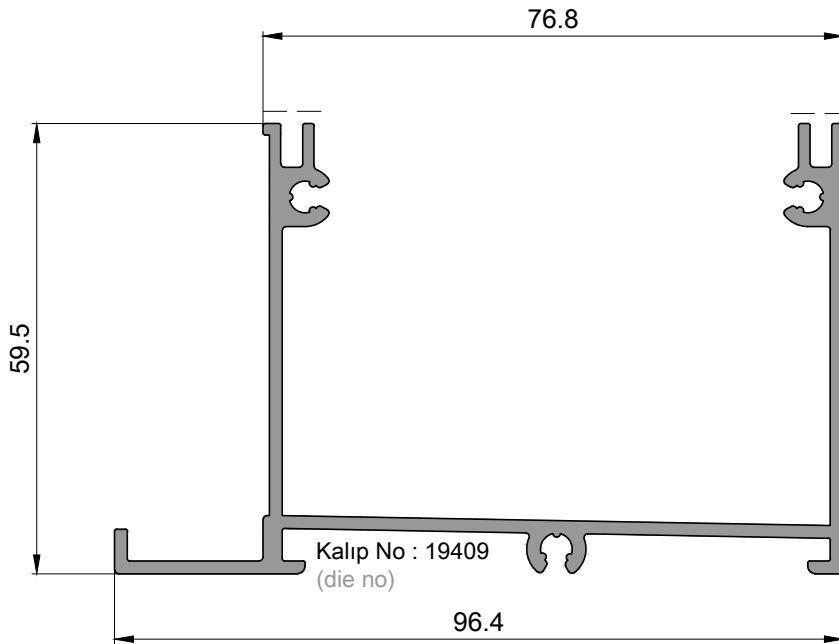

P 2467
Su Kanalı Profili
Water channel Profile
1,295kg/mt

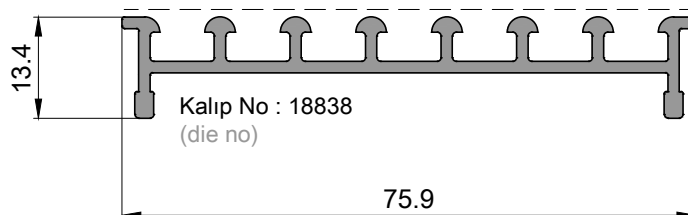

P 2327
Üst Izgara Profili
top grille profile
0,635kg/mt

P 1070

Köşe Takoz Profili / 6.220kg/mt
Corner Cleat Profile

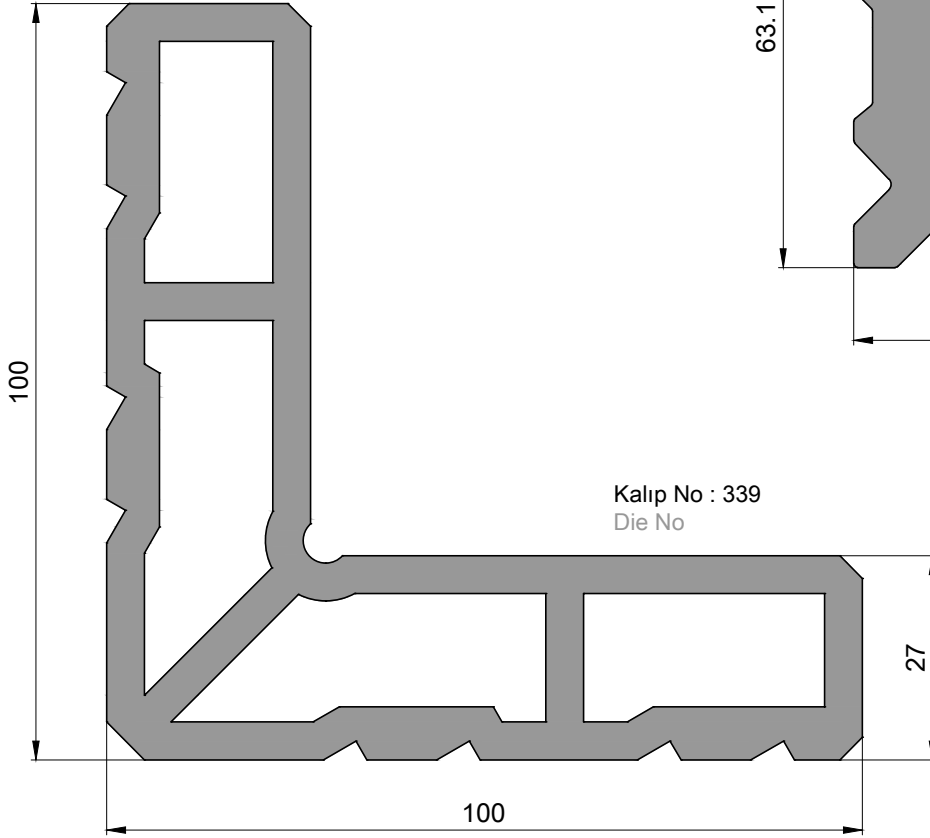

P 1117

Köşe Takoz Profili / 3.035kg/mt
Corner Cleat Profile

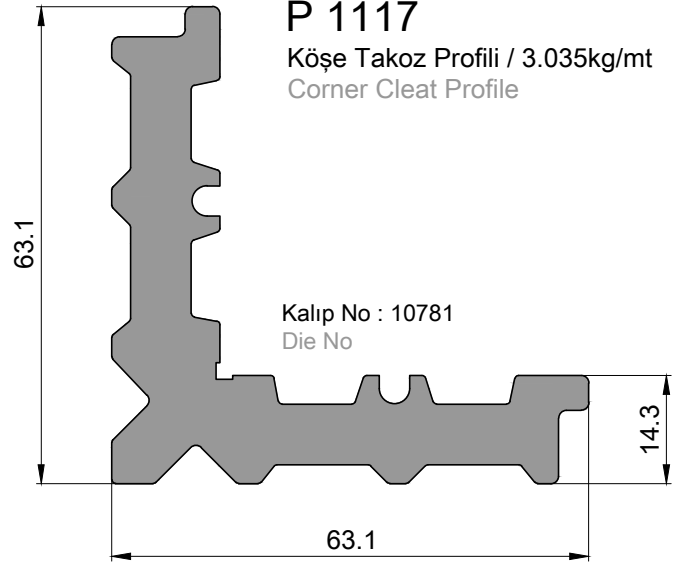

P 1016

Köşe Takoz Profili / 4.910kg/mt
Corner Cleat Profile

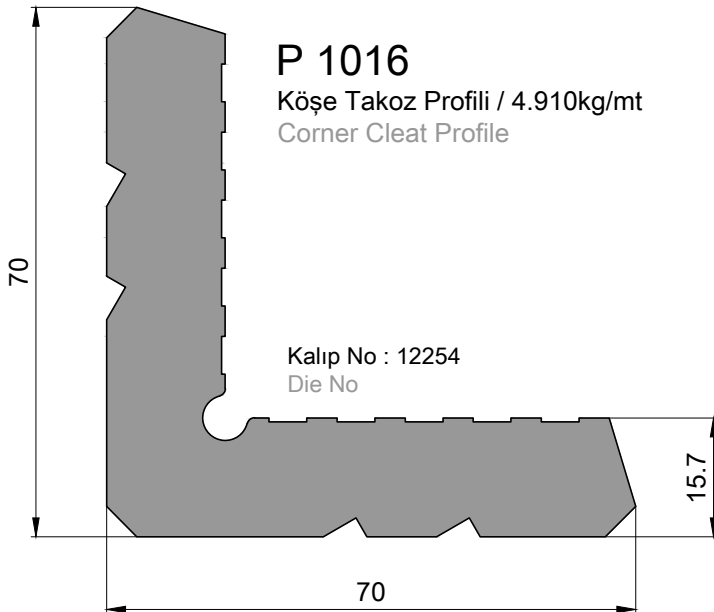

P 2158

Köşe Takoz Profili / 2,550kg/mt
Corner Cleat Profile



UNIQUEslideMS
KALDIR ve SÜR KAPI SİSTEMİ
LIFT&SLIDE DOOR SYSTEM

TEK RAYLI KASA İLE
PRENSİP SİSTEM DETAYLARI
PRINCIPAL SECTIONS for
SINGLE TRACK PROFILE

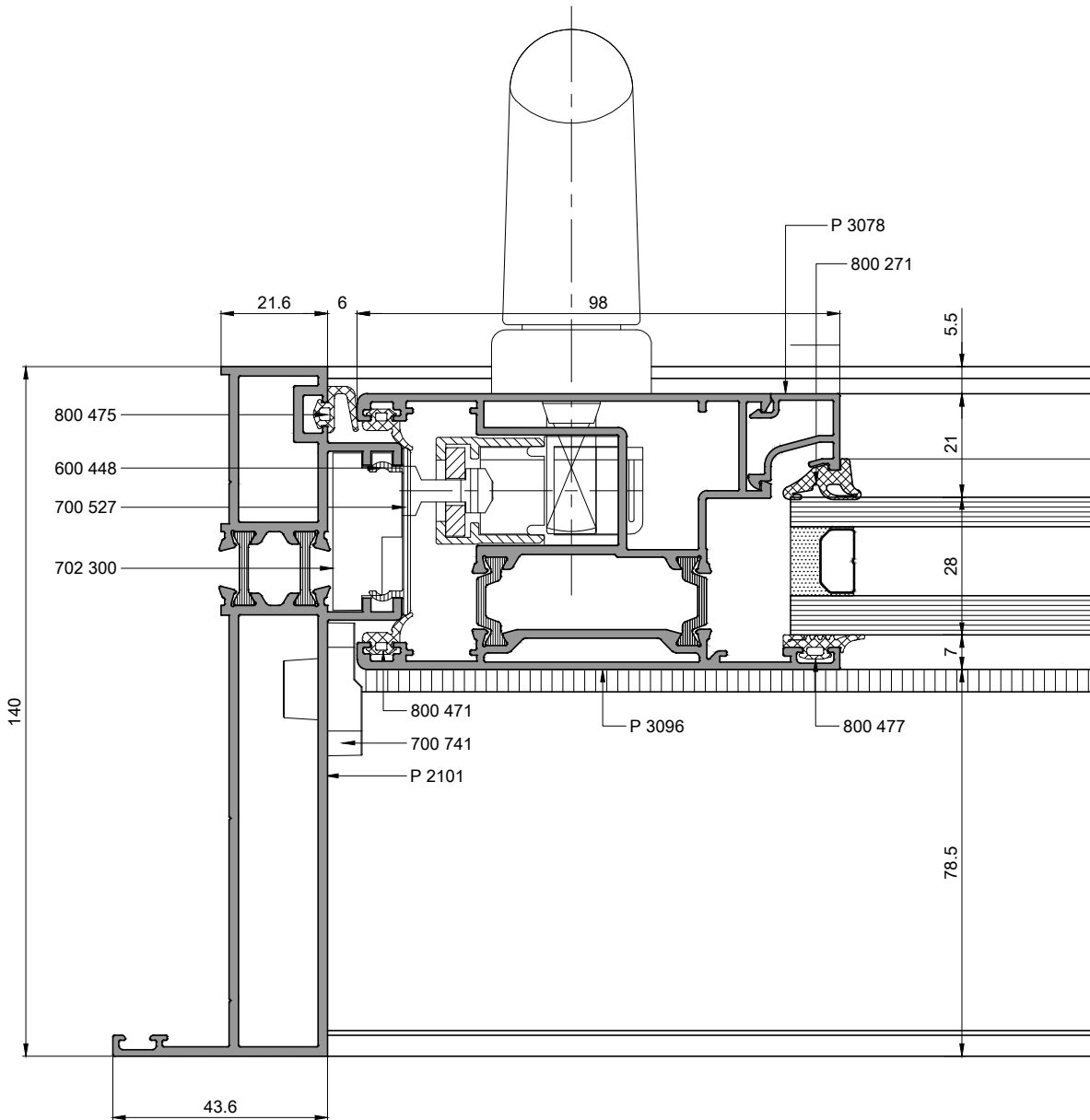
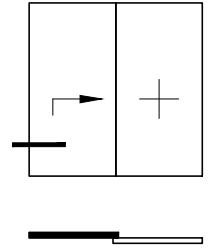

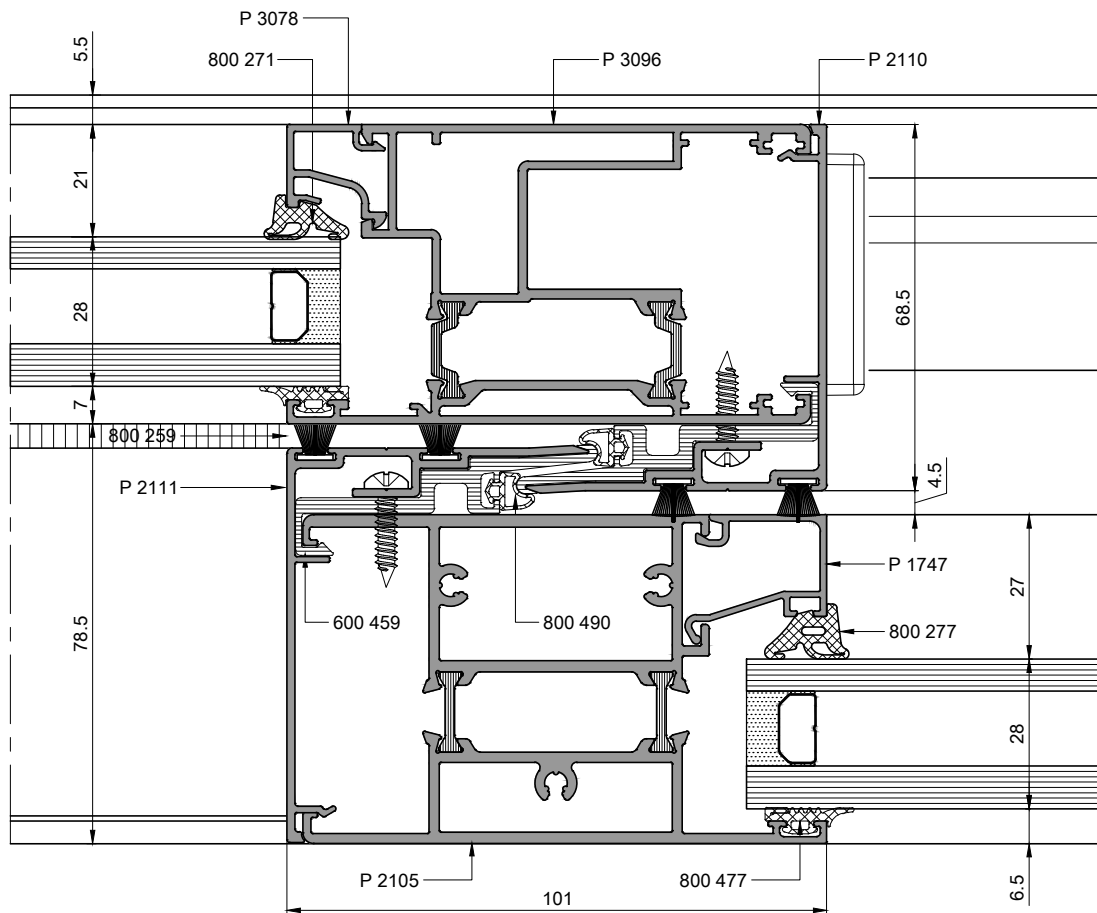
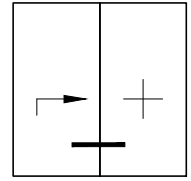

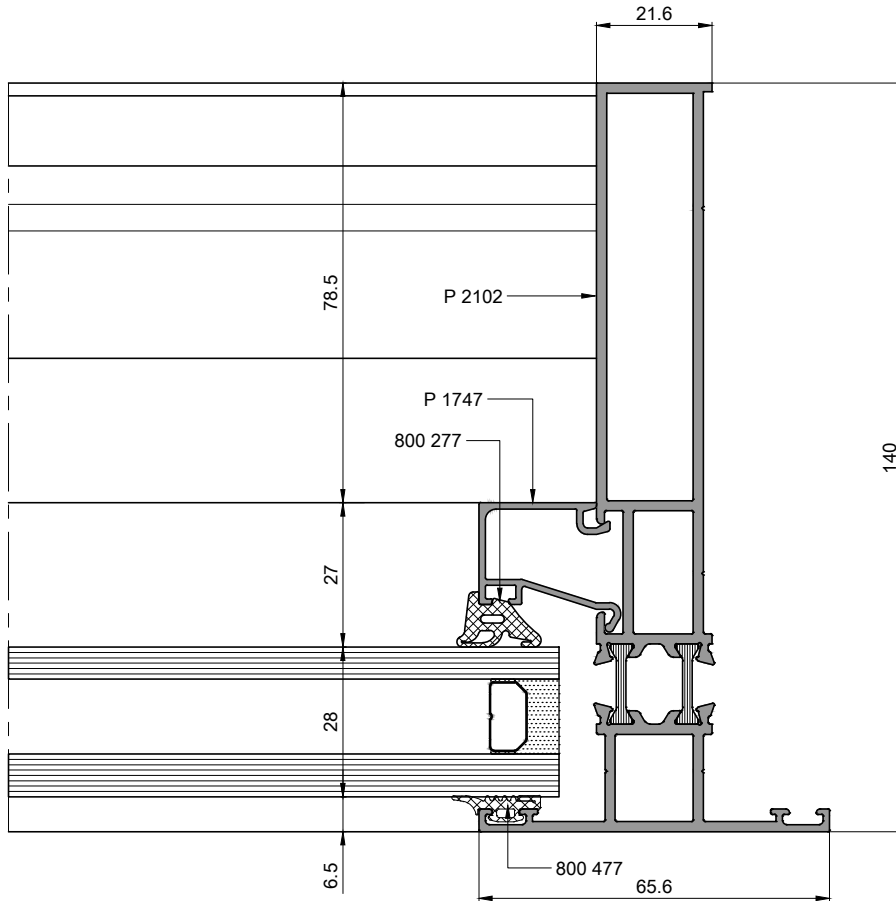
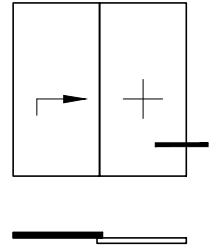

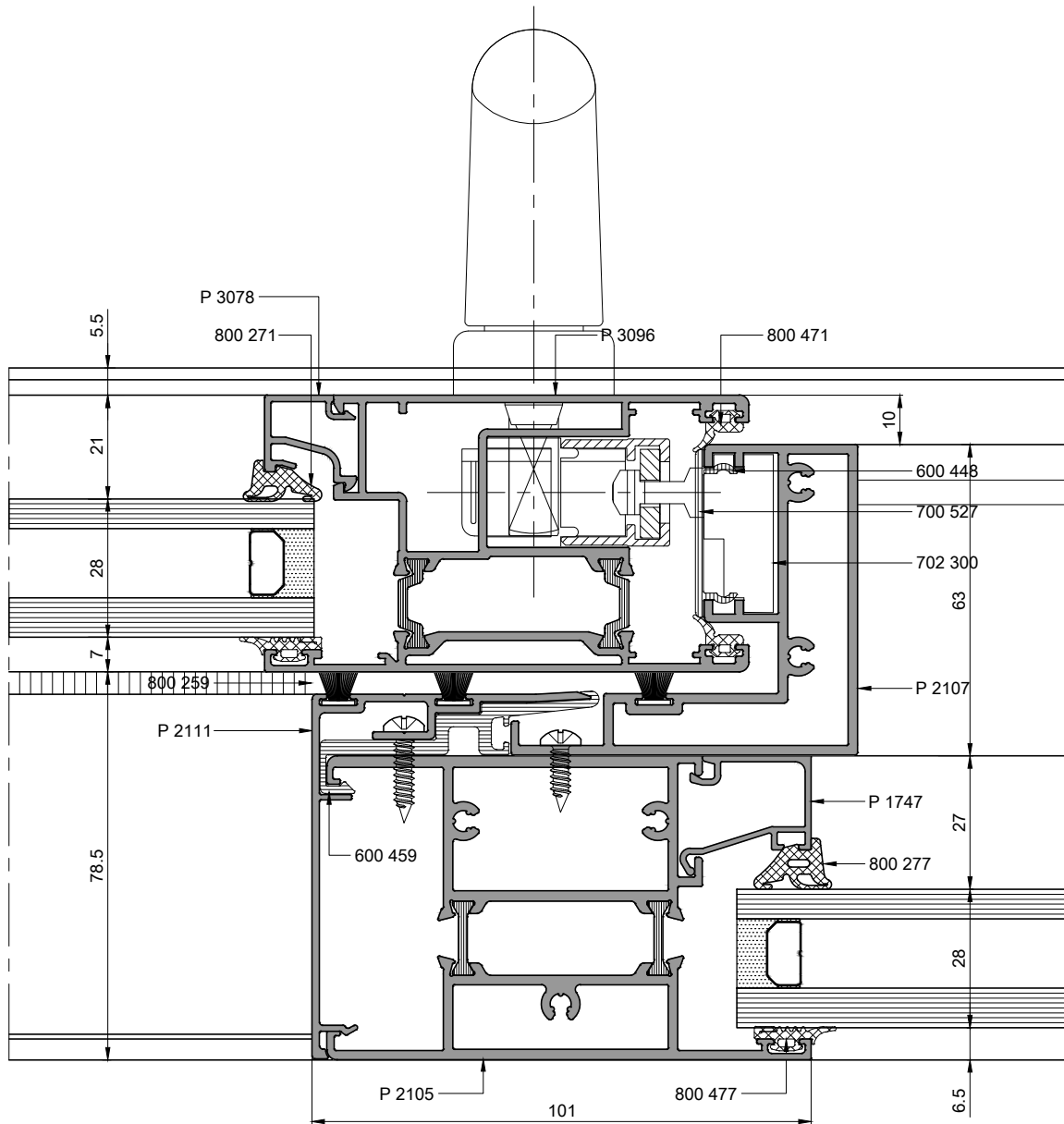
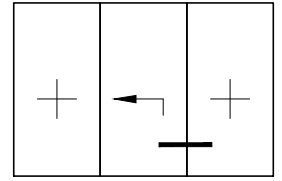

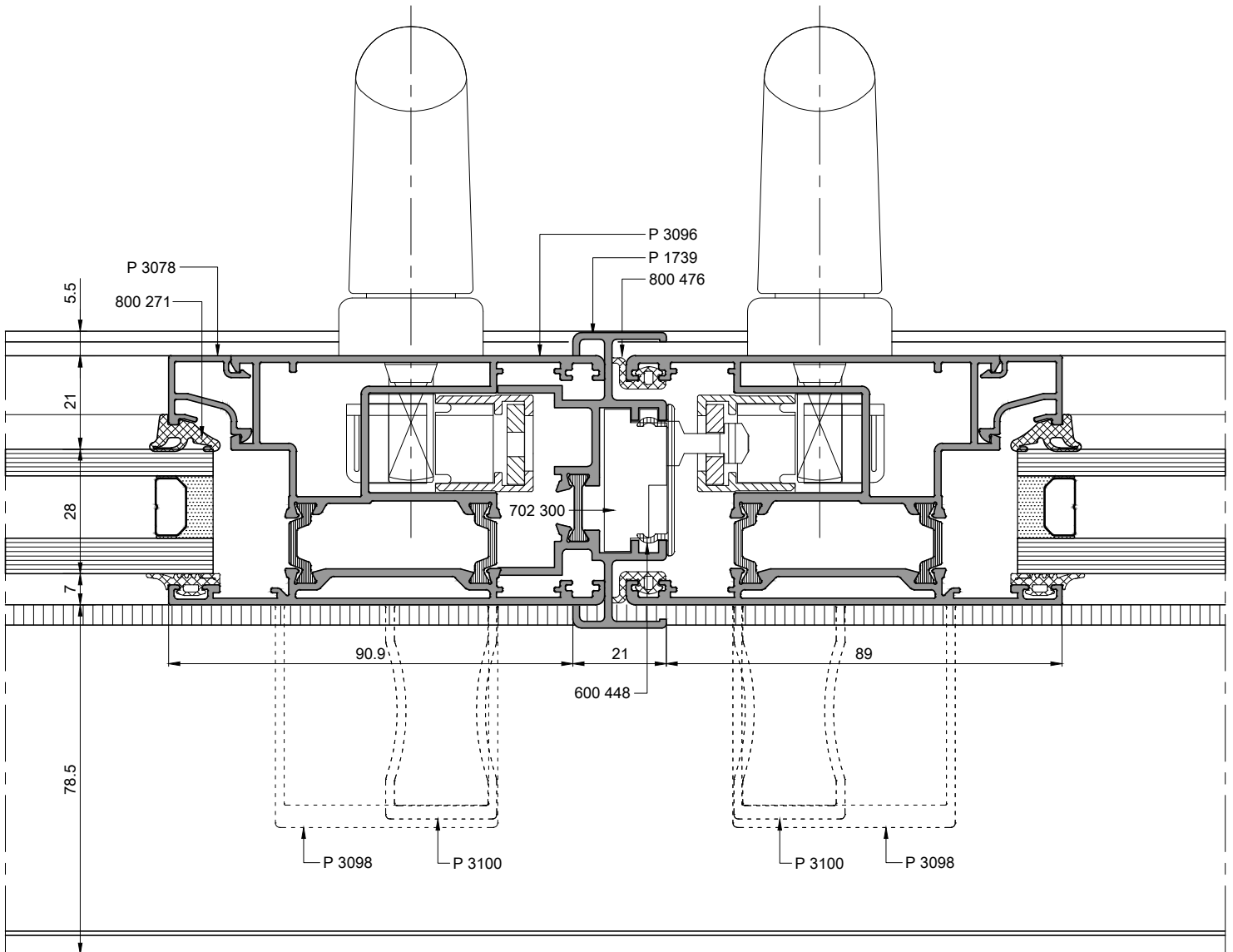
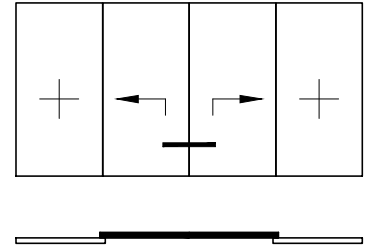

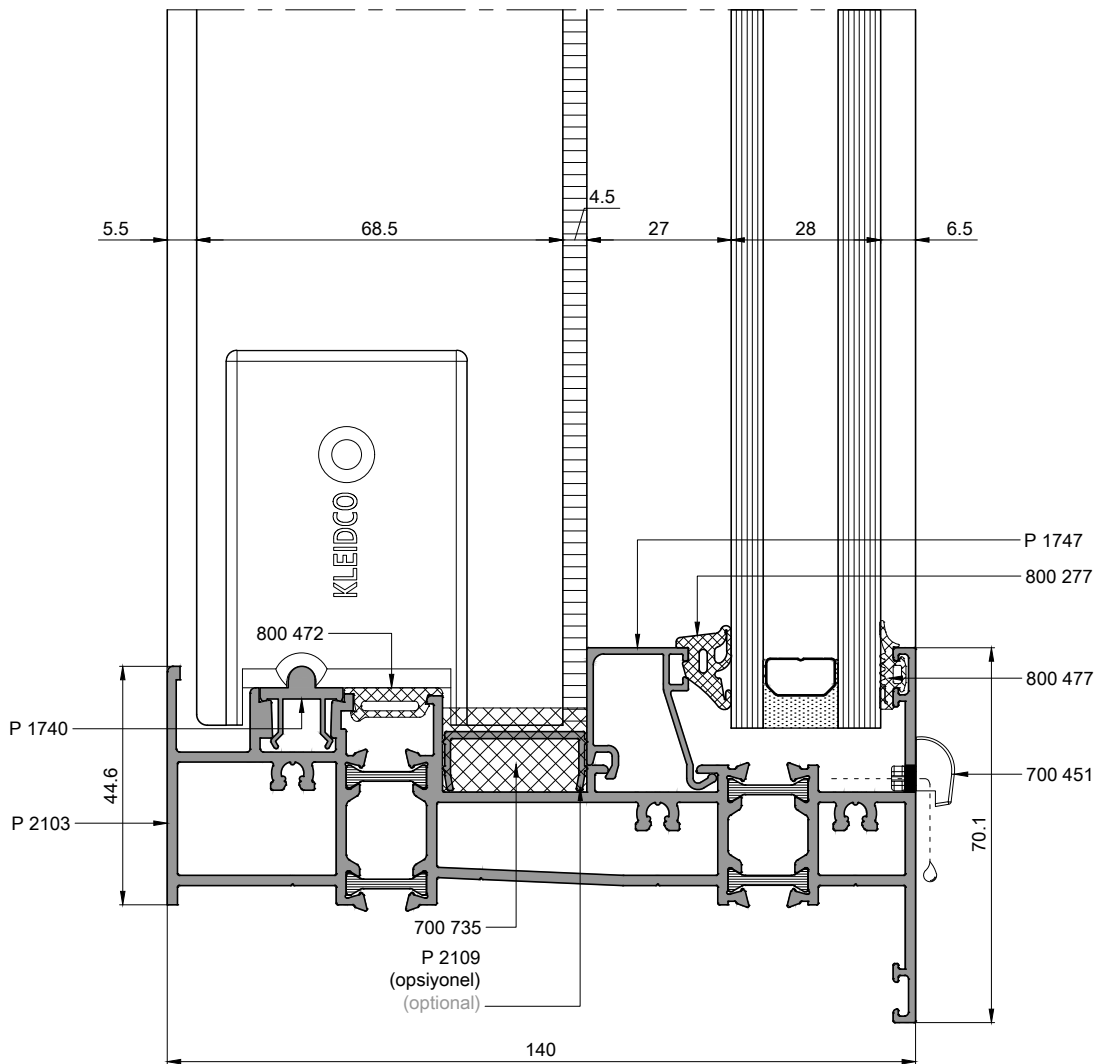
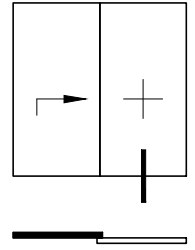

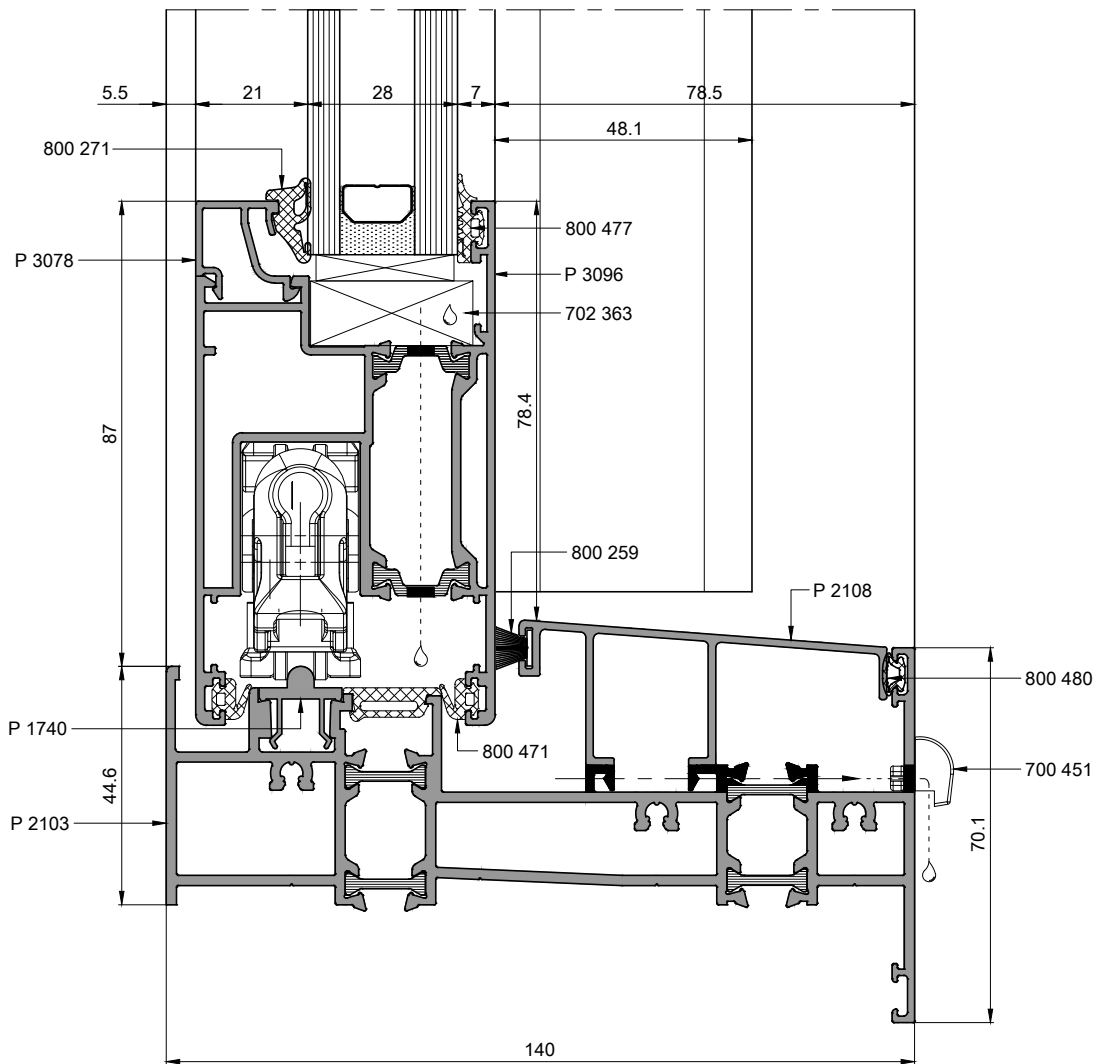
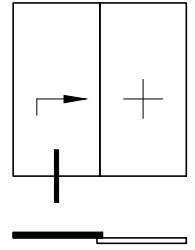

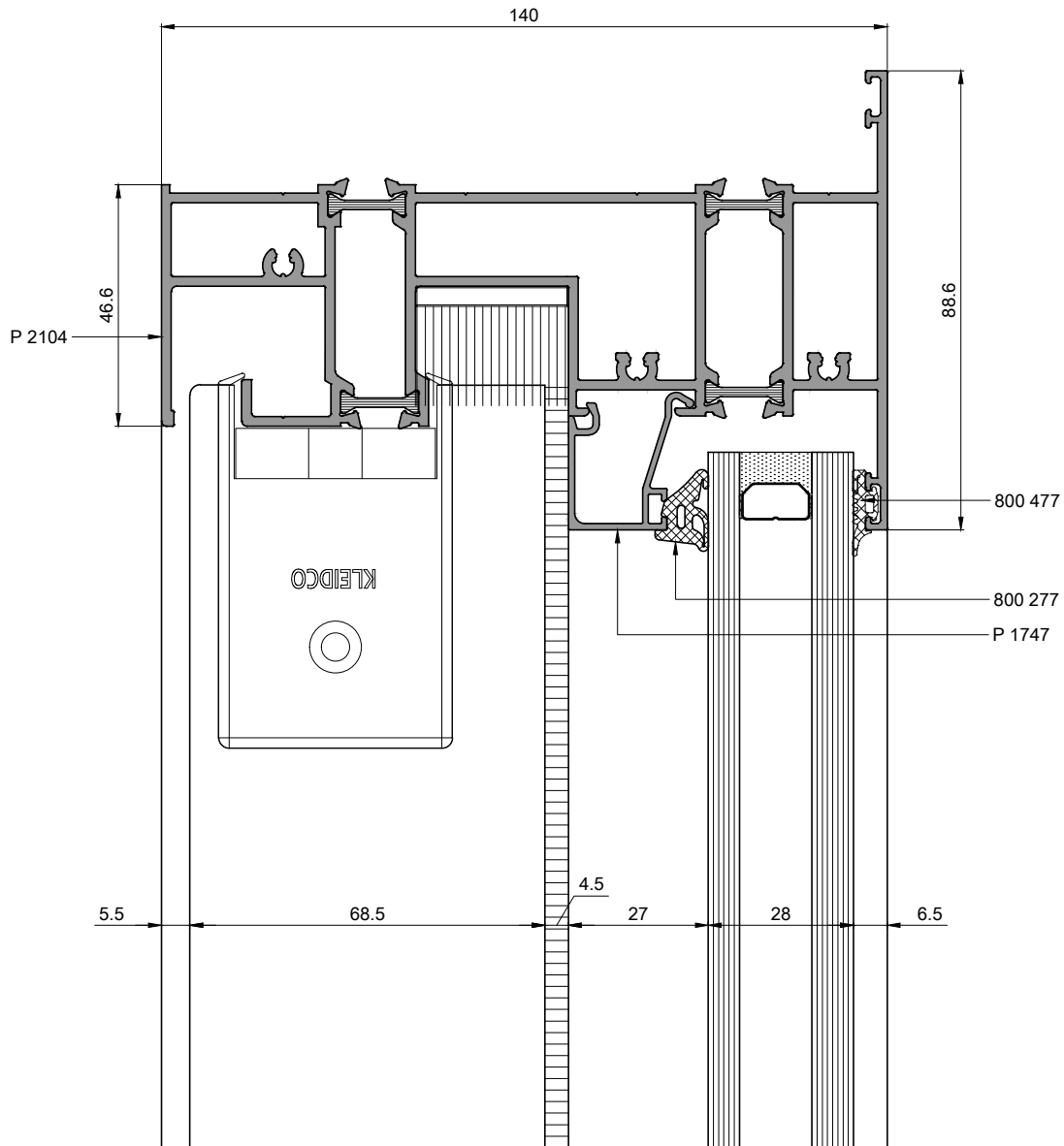
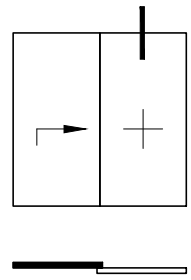

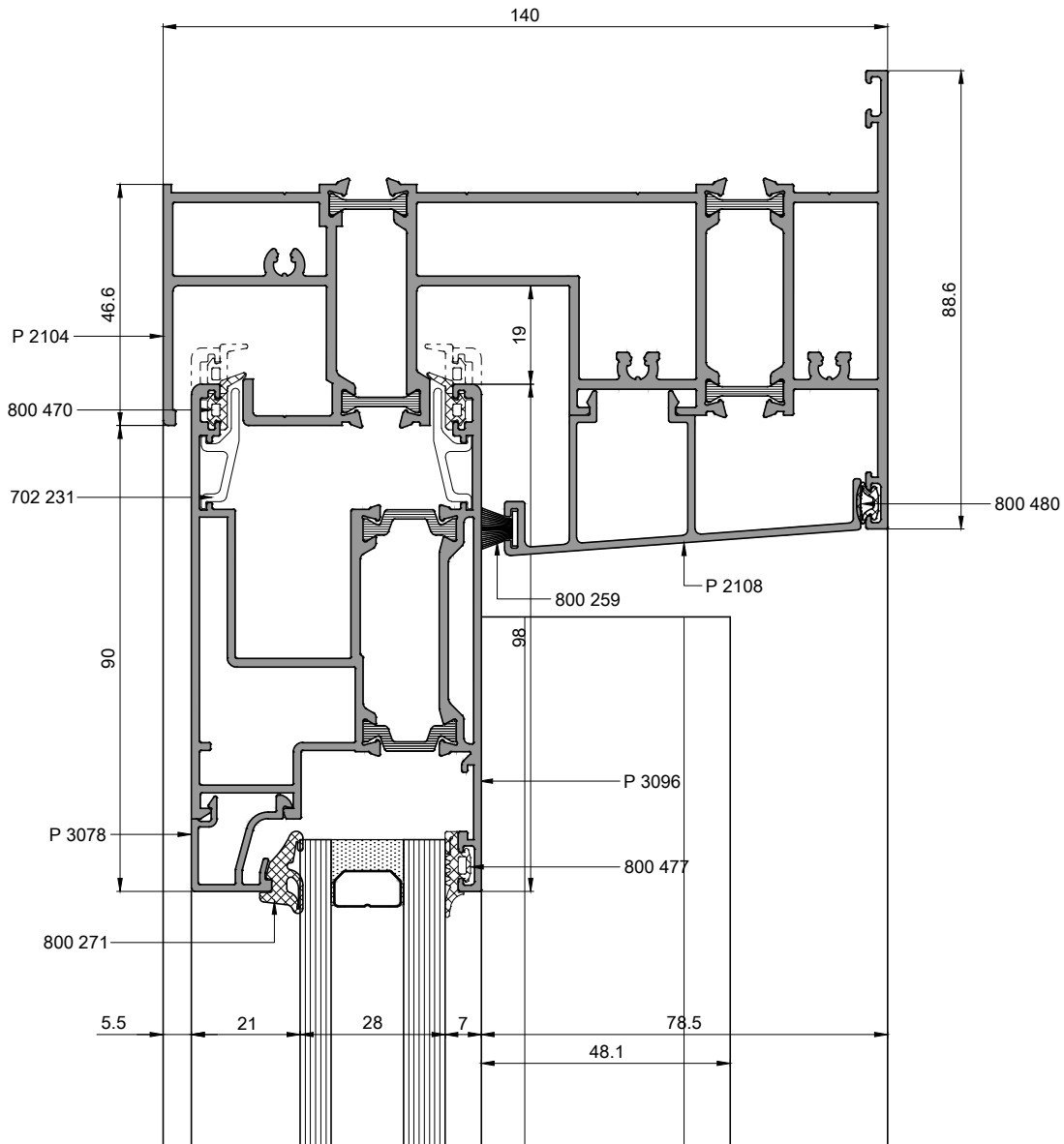
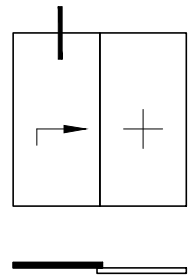

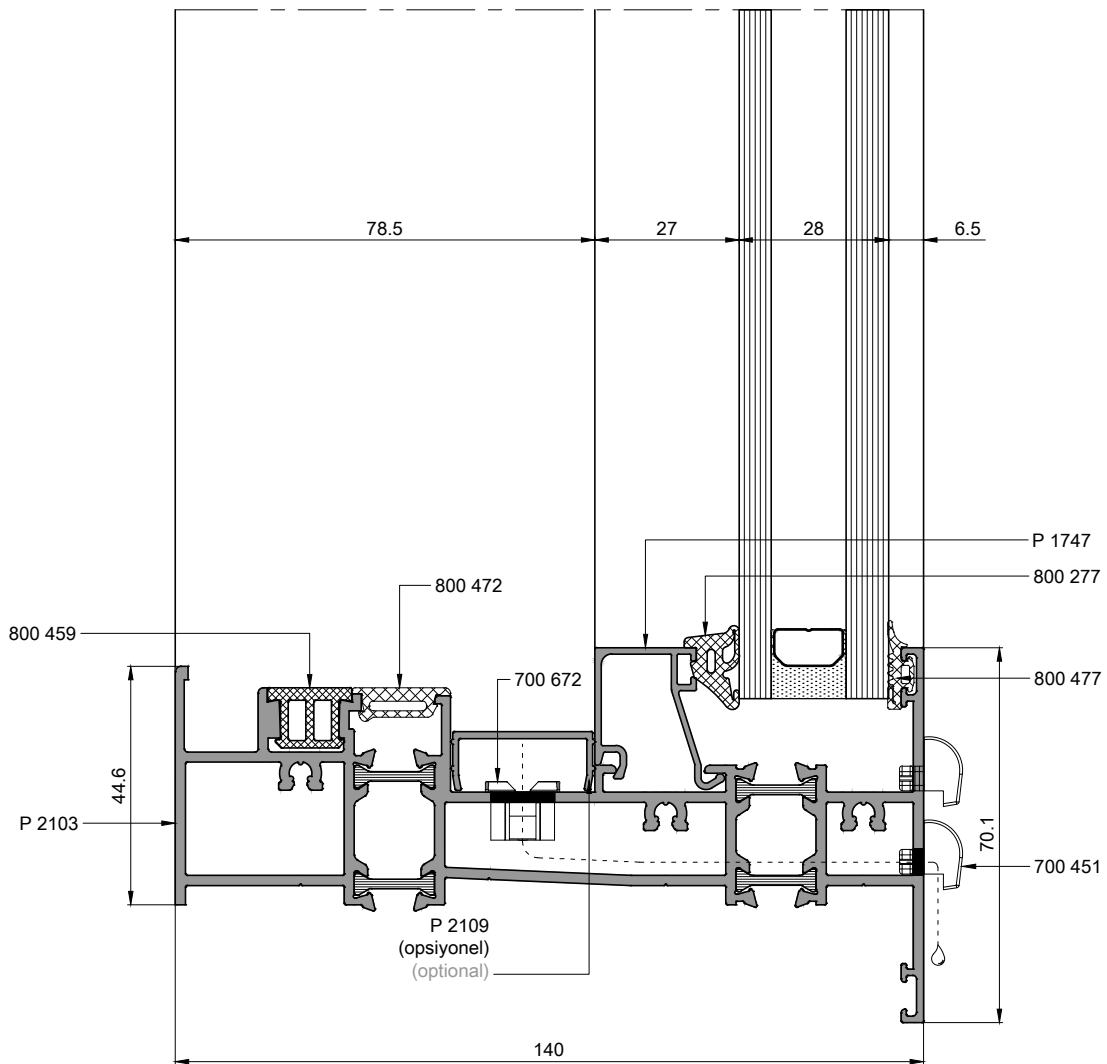
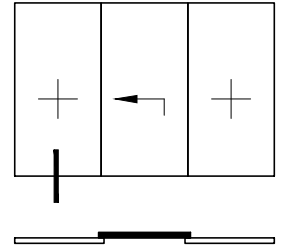

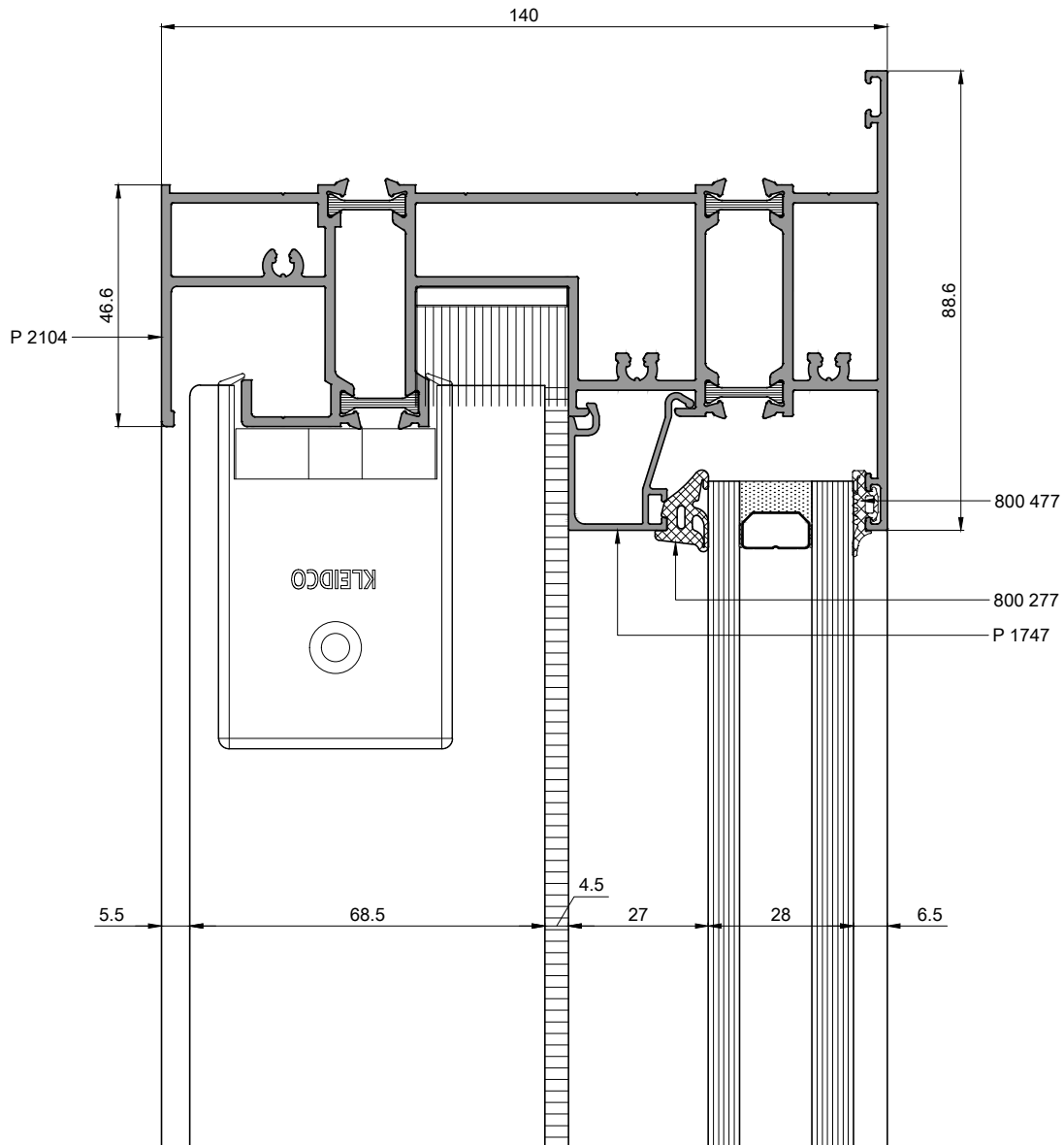
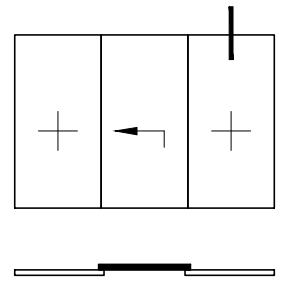

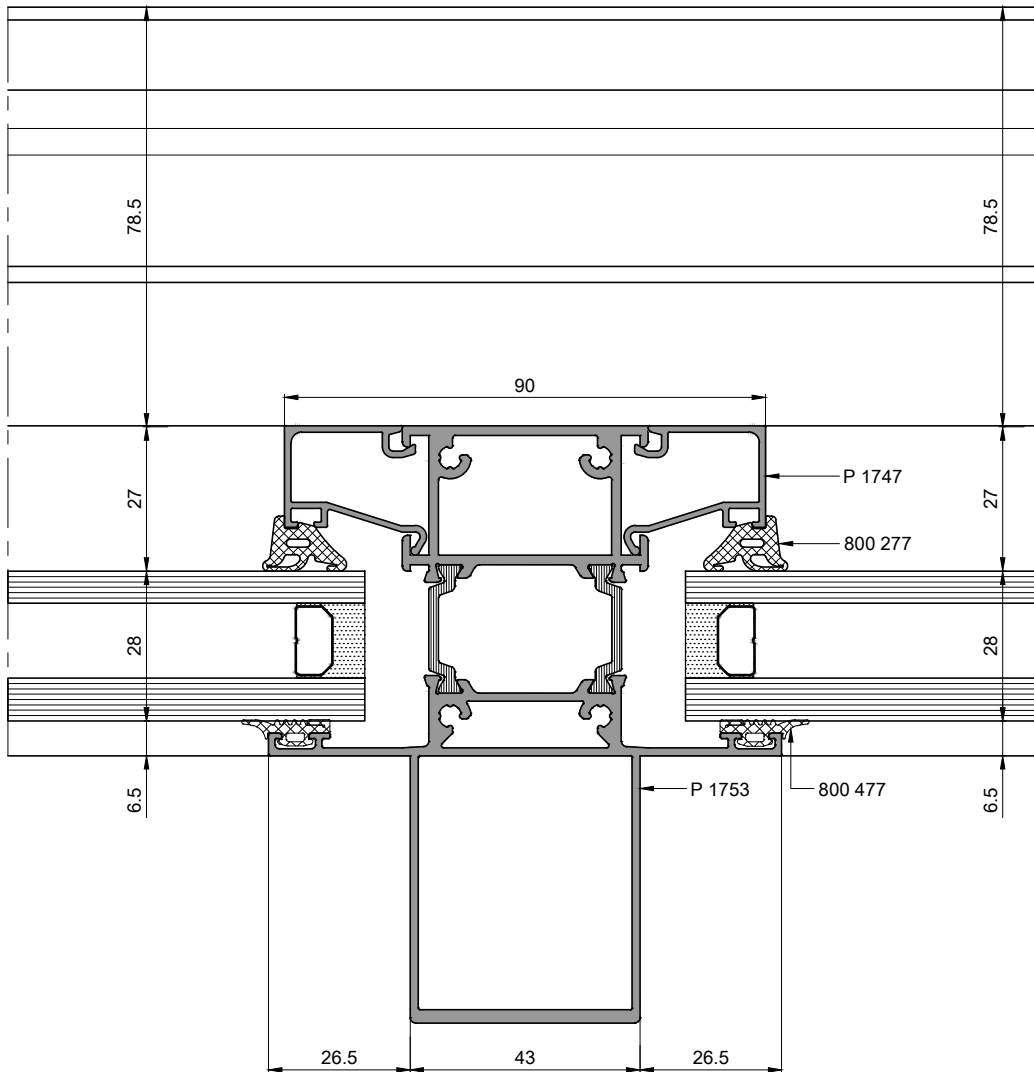
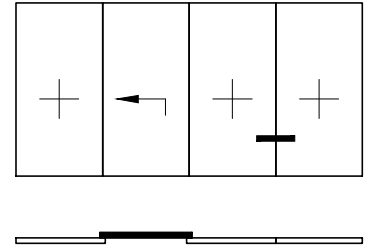

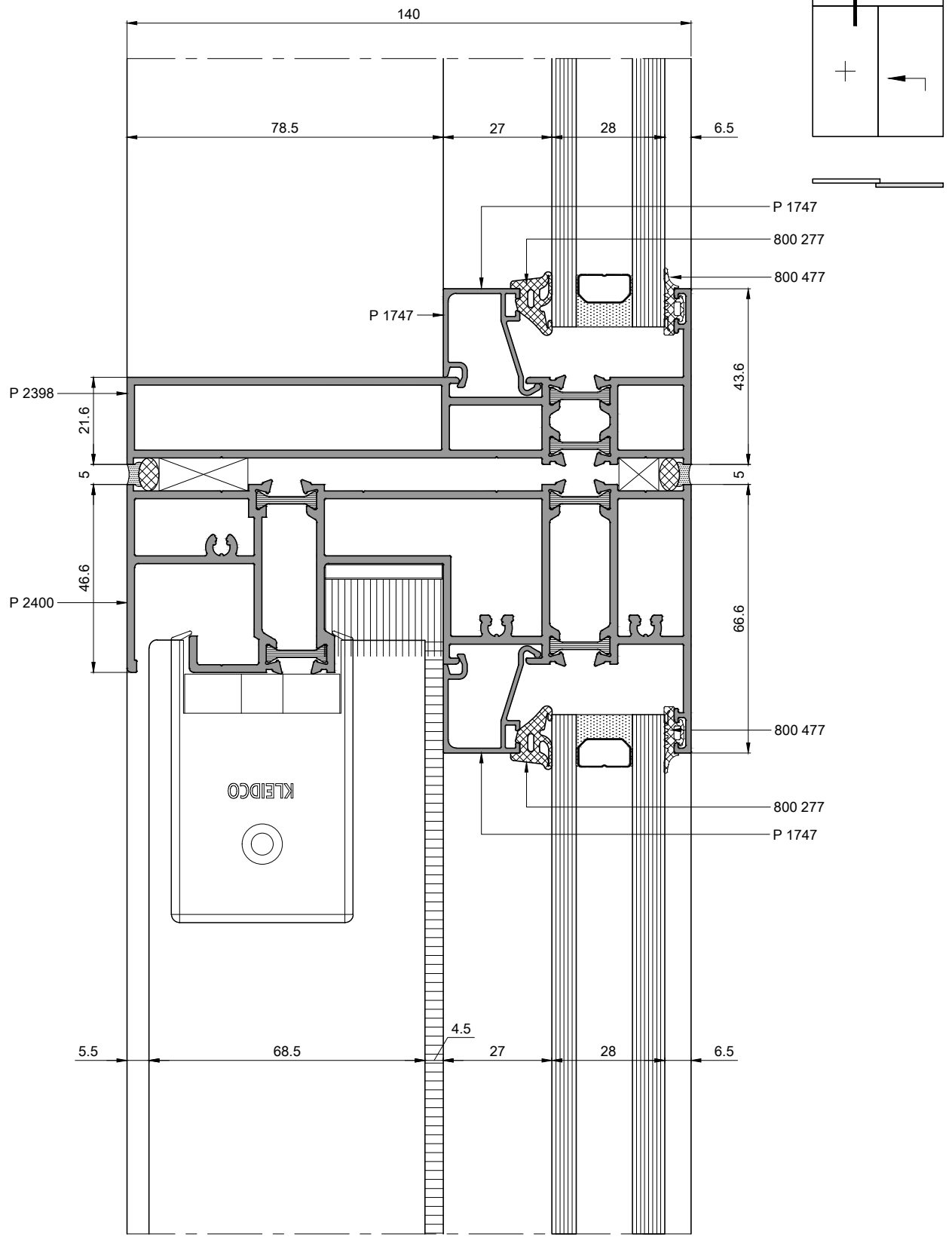

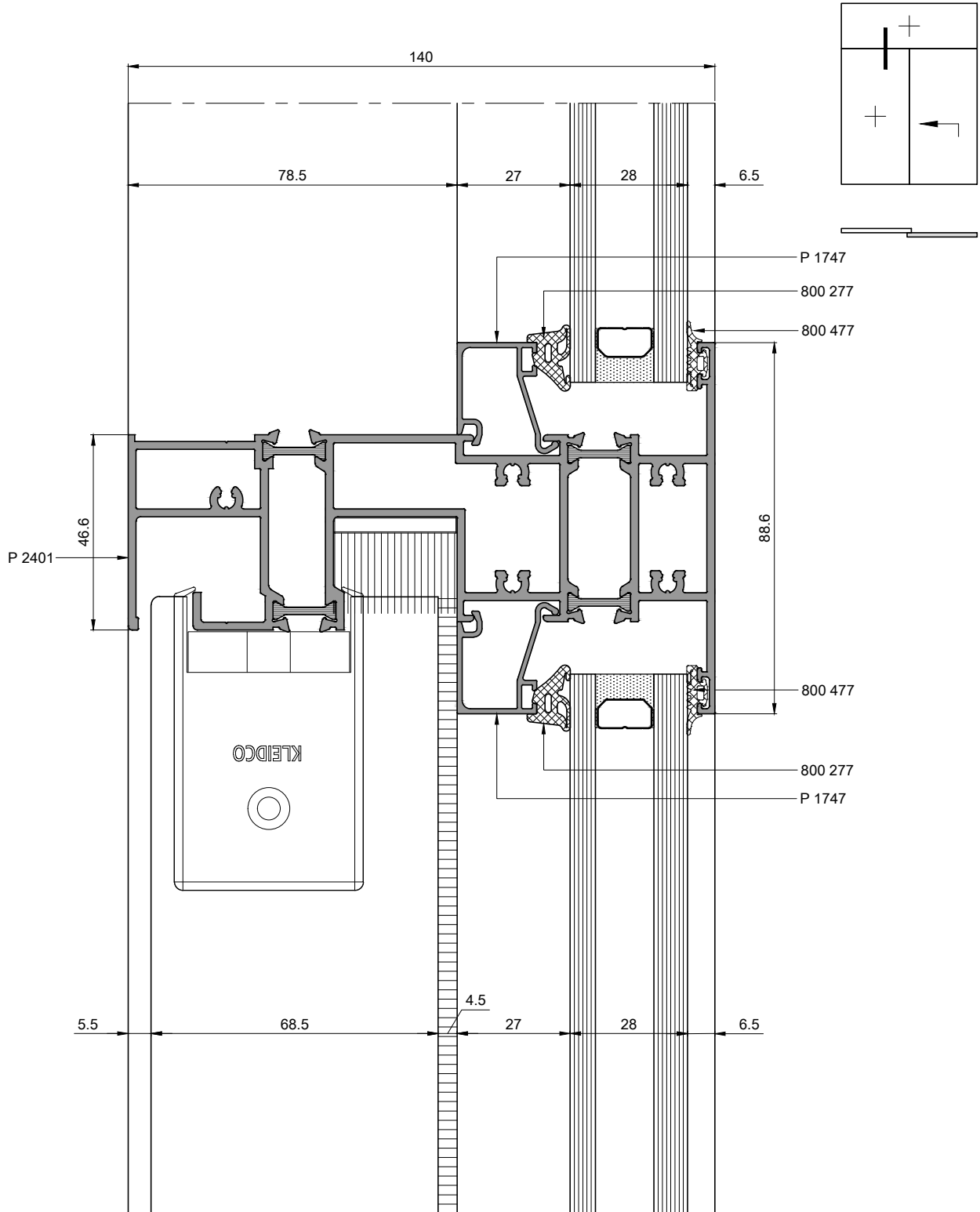

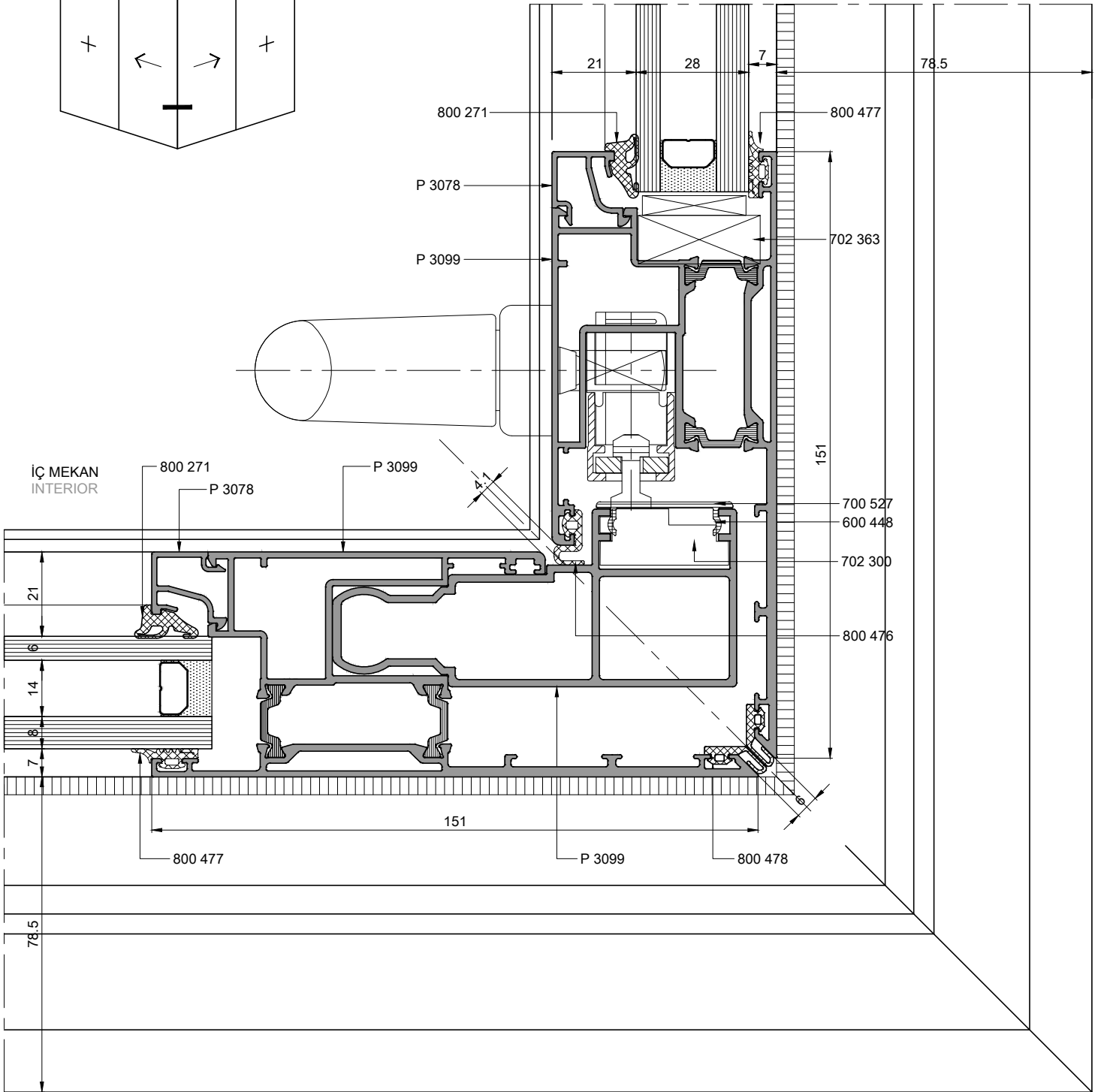
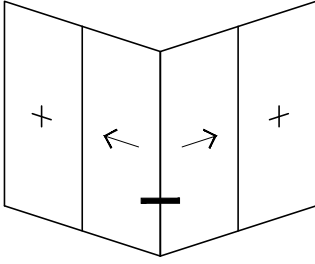

DIŞ MEKAN
EXTERIOR

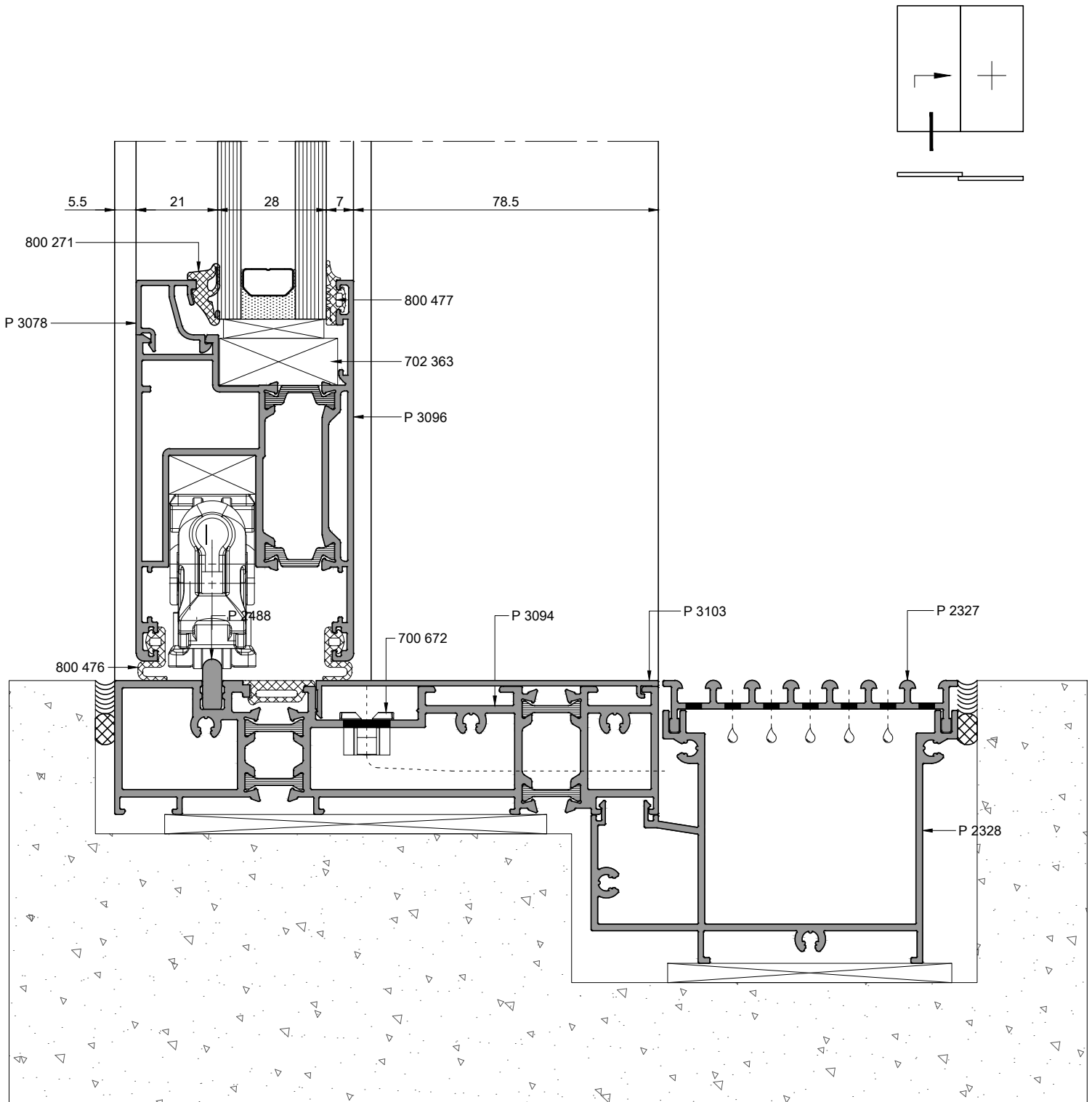

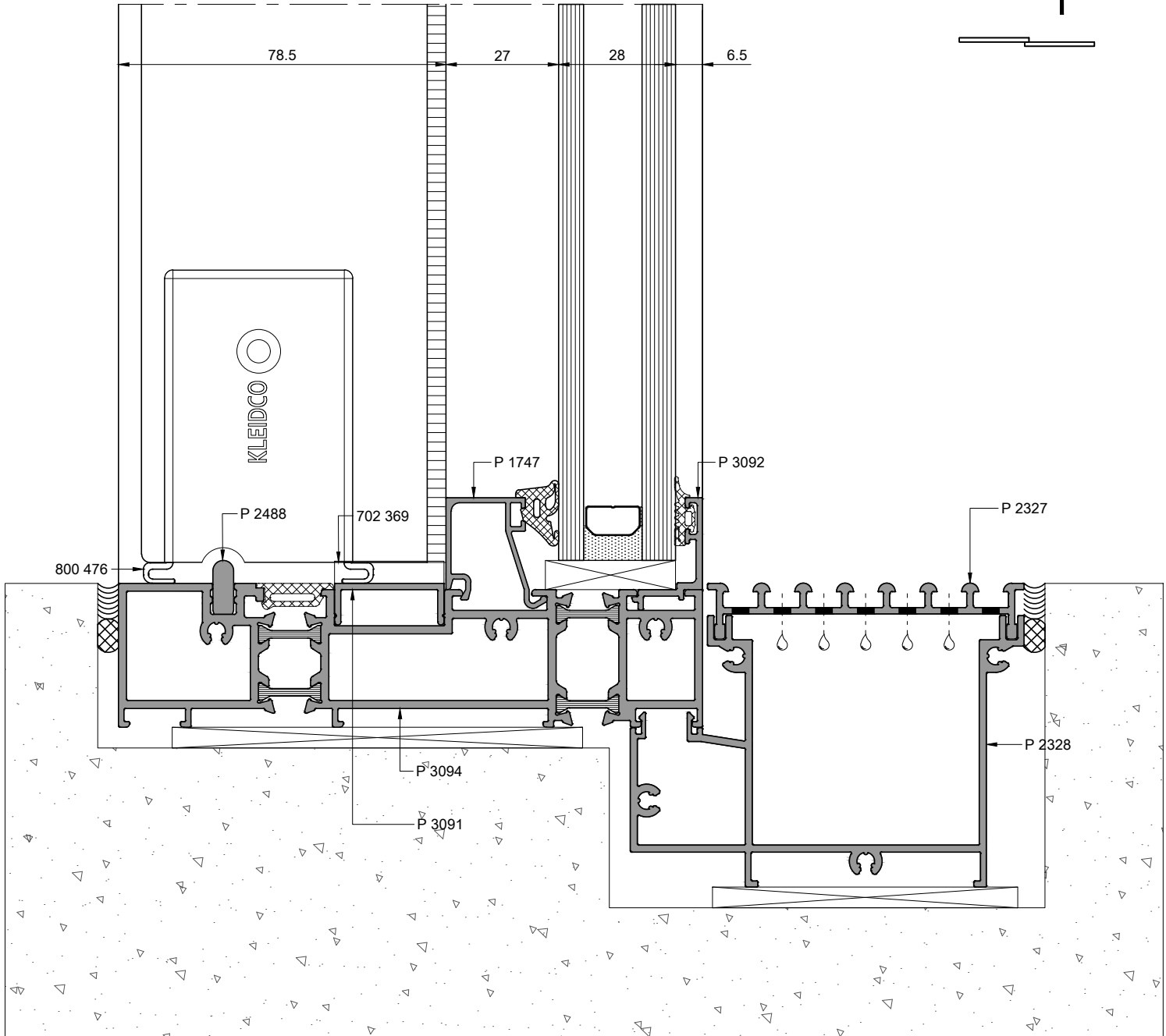
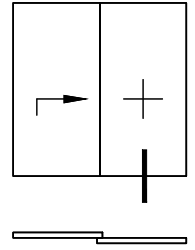

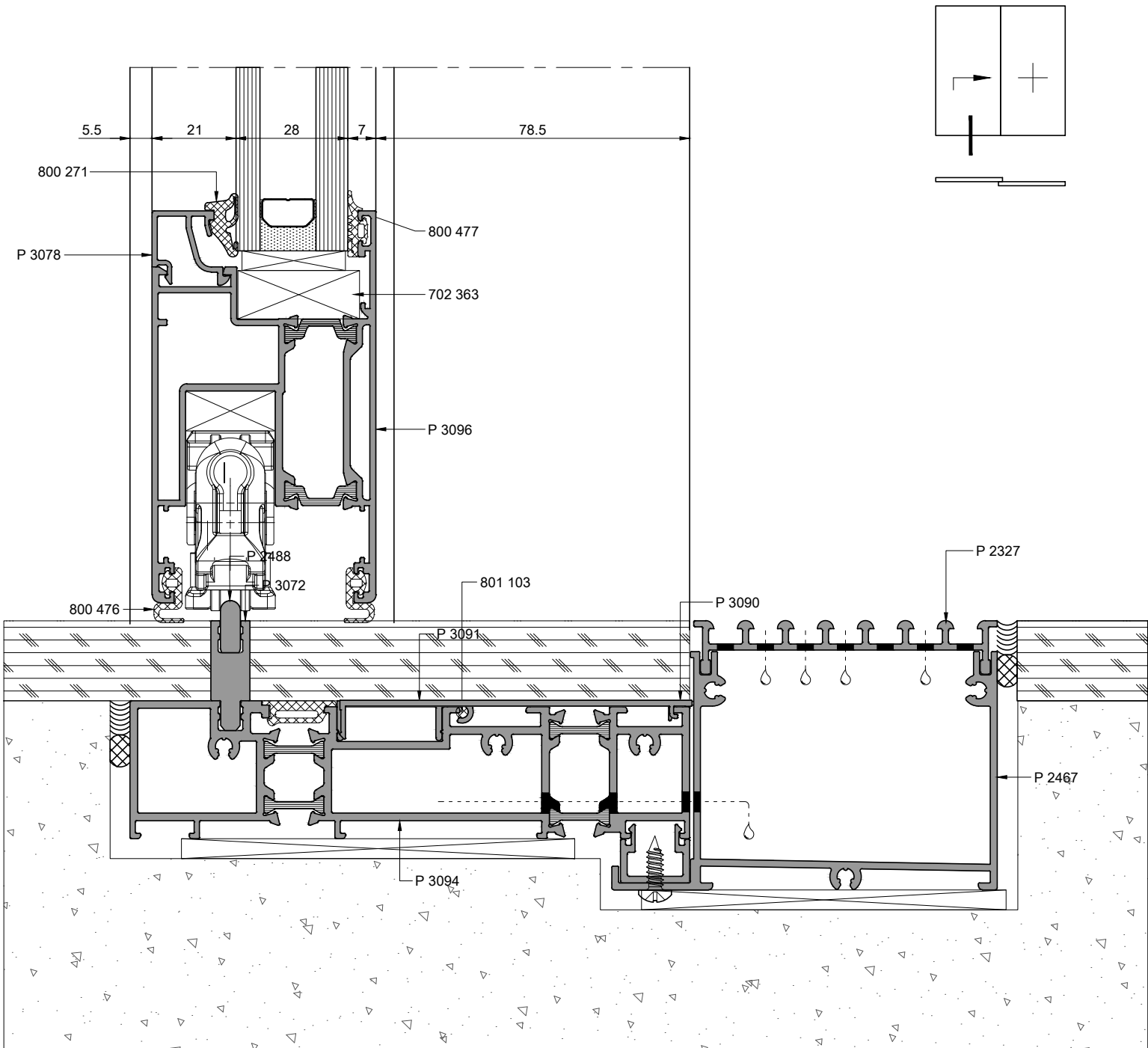

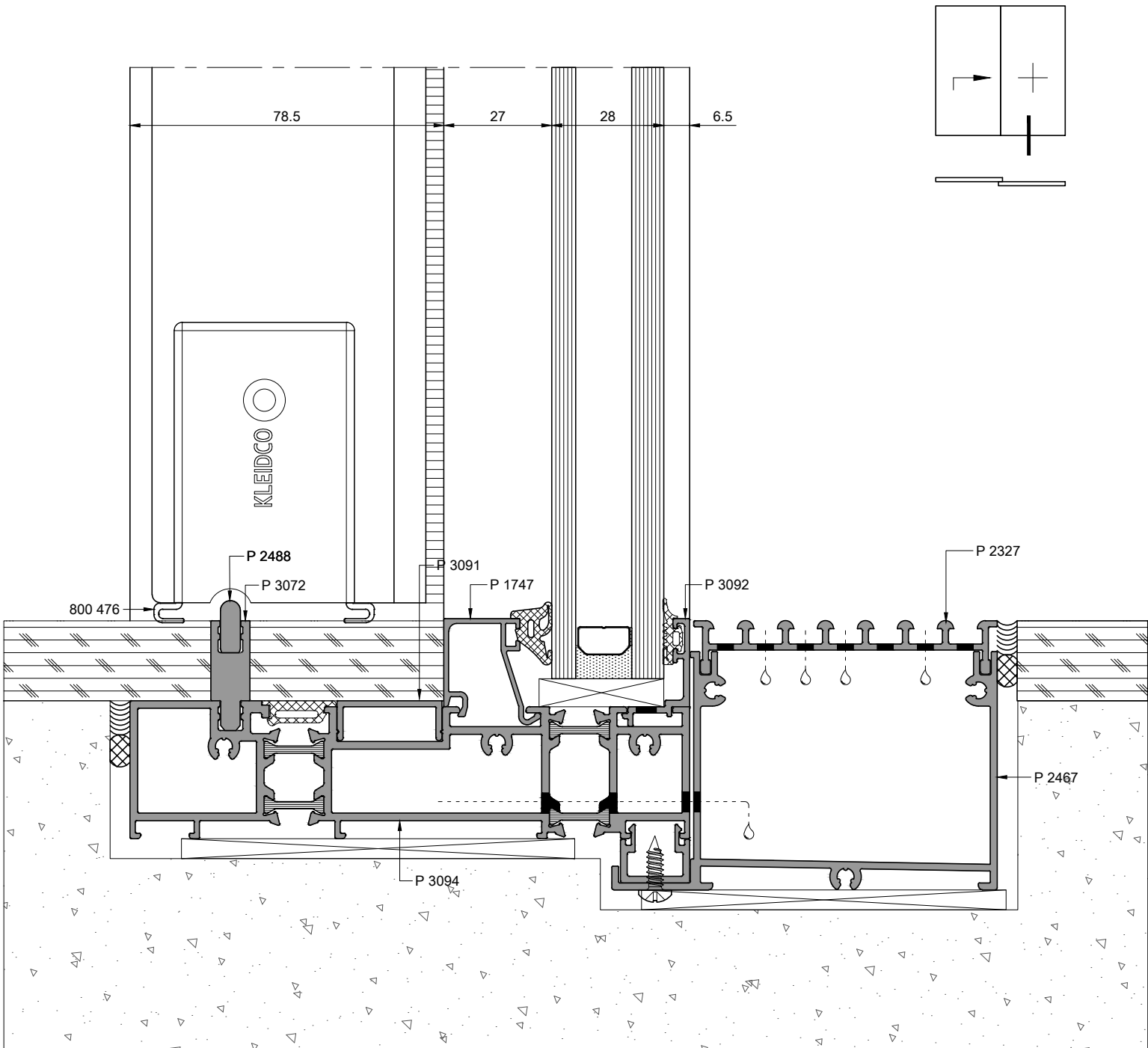

UNIQUEslideMS
KALDIR ve SÜR KAPI SİSTEMİ
LIFT&SLIDE DOOR SYSTEM

TEK RAYLI KASA İLE İNCE KANAT
PRENSİP SİSTEM DETAYLARI
PRINCIPAL SECTIONS for SLIM SASH
SINGLE TRACK PROFILE

